

# Automatización

## Fusibles aR Tipo NH Contacto Cuchilla, NH Flush End y Tipo D

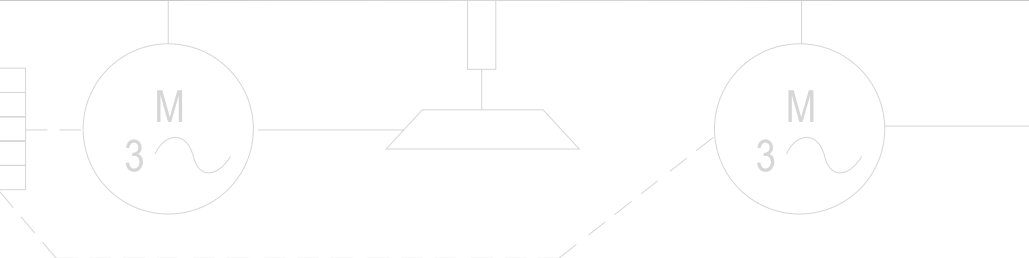

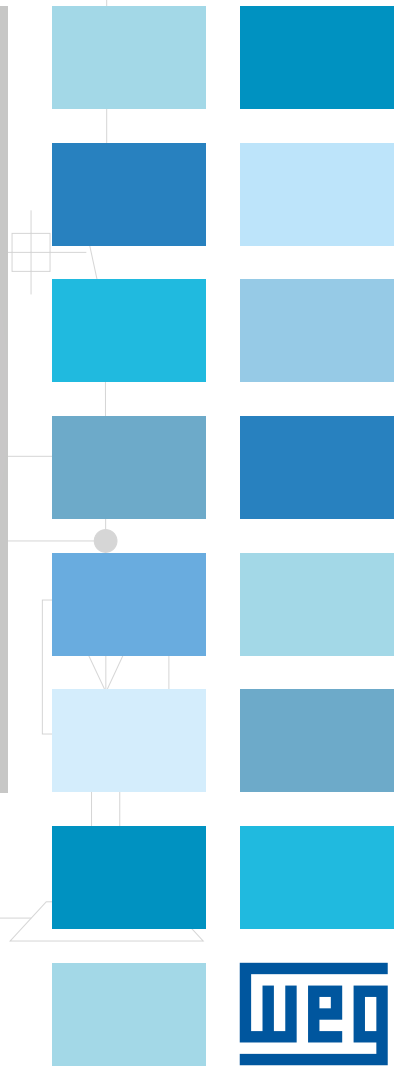
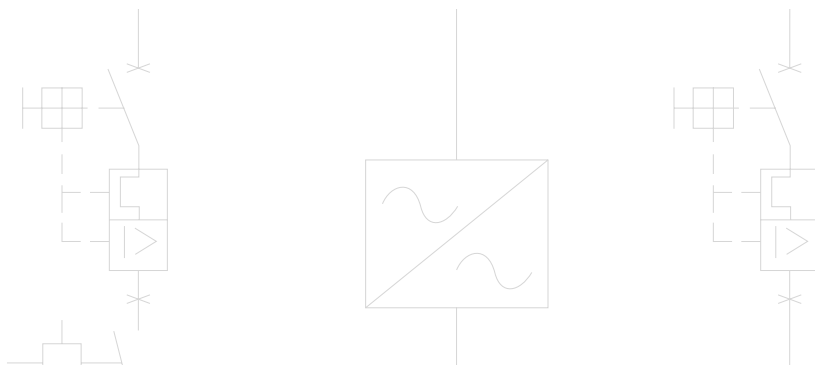
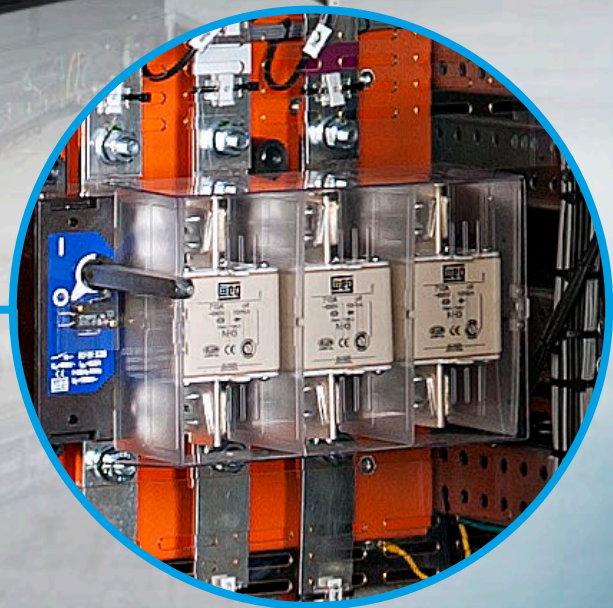
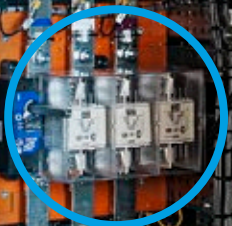

# Fusibles aR Tipo NH Contacto Cuchilla, NH Flush End y Tipo D

## Sumario

### Fusibles aR

Visión General ..... 04

### Fusibles Clase aR - Ultrarrápidos

Visión General ..... 06

### Fusibles aR - Tipo NH Contacto Cuchilla

Características Técnicas ..... 06

Accesorios ..... 08

Dimensiones ..... 09

Curvas Tiempo x Corriente ..... 11

Curvas de Limitación de Corriente ..... 12

Gráficos ..... 15

Factores de Reducción - Fusibles en Bases Individuales y Llaves Seccionadoras ..... 16

### Fusibles aR - Tipo NH Flush End

Características Técnicas ..... 17

Accesorios ..... 18

Dimensiones ..... 18

Curvas Tiempo x Corriente ..... 19

Curvas de Limitación de Corriente ..... 19

Gráficos ..... 20

### Anexos

Anexo 1 - Criterios de Dimensionamiento de Fusibles aR ..... 22

Anexo 2 - Tablas de Dimensionamiento de Fusibles aR para Protección de Convertidores CFW y Arrancadores Suaves SSW ..... 24





# Fusibles aR

Los fusibles WEG son fabricados y probados conforme normas internacionales, en las corrientes de 4 a 2.000 A. Disponibles en las siguientes características constructivas y de protección:

## Fusibles Ultrarrápidos Clase aR, Tipo NH Contacto Cuchilla y Tipo NH Flush End

- Para protección contra cortocircuito en semiconductores/equipamientos electrónicos hasta 690 V ca.

### Datos Generales

Tipo de fusible	Tensión máxima de trabajo	Capacidad de interrupción	Corriente ( $I_n$ )	Tamaños	Normas de conformidad
Clase aR ultrarrápido tipo NH contacto cuchilla	690 V ca	100 kA / 690 V ca	20 a 1.000 A	000, 00, 1, 2 y 3	IEC 60269-4 UL 248-13
Clase aR ultrarrápido tipo NH flush end	690 V ca	200 kA / 690 V ca	450 a 2.000 A	3 y 23	IEC 60269-4 UL 248-13



### Funcionamiento del Fusible

En cortocircuito o sobrecarga, el elemento fusible se funde, abriendo el circuito eléctrico e interrumpiendo el pasaje de corriente.

Durante el cortocircuito, habrá una limitación de la corriente de cortocircuito presumida, conforme la figura de al lado:

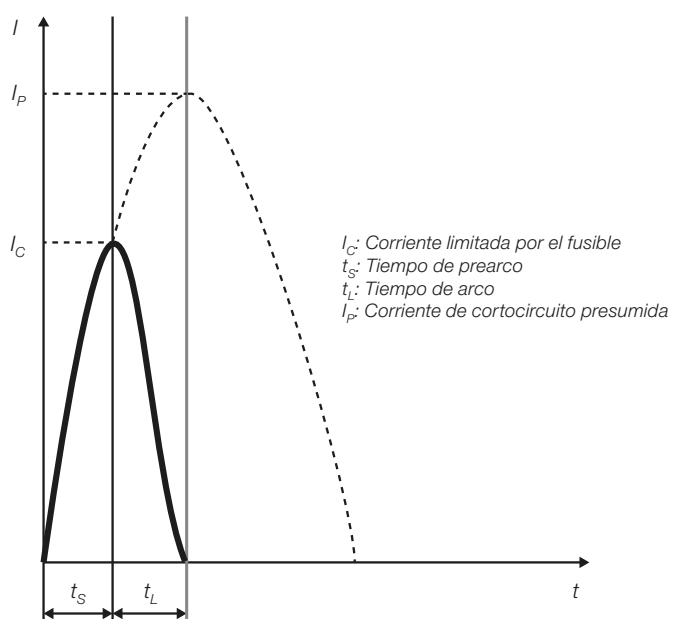

## Fusibles Clase aR - Ultrarrápidos

### Visión General

Los fusibles aR ultrarrápidos tienen como función la protección contra cortocircuito de semiconductores que pueden ser encontrados, por ejemplo, en dispositivos electrónicos de baja tensión como convertidores de frecuencia y arrancadores suaves. Fabricados y probados de acuerdo con las normas IEC 60269-4 y UL 248-13, con cuerpos cerámicos cuadrados o rectangulares, los fusibles ultrarrápidos están disponibles en dos formas constructivas:

#### Con Conexiones Tipo Contacto Cuchilla (Blade Contact)



Disponibles en los modelos:

- FNH00 - tamaño 00
- FNH000 - tamaño 000
- FNH1 - tamaño 1
- FNH2 - tamaño 2
- FNH3 - tamaño 3

#### Con Conexiones Tipo Rosca (Flush End)



Disponibles en los modelos:

- FNH3FEM
- FNH23FEA  
(2 fusibles en paralelo)

### Protección Contra Cortocircuito en Circuitos CA

Por ser de la clase aR, los fusibles ultrarrápidos no poseen protección contra sobrecargas.

No pueden operar por encima de su corriente nominal, conforme es indicado en la curva tiempo x corriente. En caso contrario, el fusible sufrirá una sobrecarga térmica que reducirá su capacidad de interrupción y su vida útil.

De esta forma, para la completa protección del equipo, es obligatorio el uso de algún dispositivo complementario de protección contra sobrecarga.

### Limitador de Corriente

Para valores elevados de múltiplos de corriente, el fusible actúa rápidamente, abriendo el circuito e impidiendo que el valor de corriente de cortocircuito presumida  $I_P$  sea alcanzado.

## Fusibles Clase aR - Tipo NH Contacto Cuchilla

### Características Técnicas

Los fusibles aR ultrarrápidos tipo NH contacto cuchilla son montados en cuerpo cerámico de alta calidad, llenado con arena de cuarzo impregnada, elemento fusible en plata pura y terminales/cuchillas en cobre plateado.

Esta construcción proporciona un excelente aislamiento eléctrico, robustez mecánica y capacidad de resistencia contra shocks térmicos durante el apagado del fusible y valores de  $I^2t$  reducidos.





#### FNH000

Tamaño	Descripción	Características						
		Tensión de operación (V ca)	Capacidad de interrupción (kA)	Rango de corriente (A)	$I^2t$ prearco (A <sup>2</sup> s)	$I^2t$ de arco en 690 V (A <sup>2</sup> s)	Potencia disipada (W) 0,8 ln(1)	Código
000	FNH000	690	100	20	32	175	2,8	13735555
				25	46	330	3,5	13735656
				35	56	400	6,2	13737105
				40	110	670	6,2	13737107
				50	250	1.550	6,5	13737128
				63	410	2.200	8	13737129
				80	570	3.200	12	13737130
				100	980	6.200	14	13737131
125	1.400	8.100	20,5	13737132				

# Fusibles Clase aR - Tipo NH Contacto Cuchilla

## Características Técnicas

100 kA / 690 V ca

Características técnicas							
Referencia	Tamaño	Corriente (A)	I <sup>2</sup> t - prearco	I <sup>2</sup> t total - arco	Potencia disipada (W) 0,8 I <sub>n</sub>	Código	
			690 V ca (A <sup>2</sup> s)				
	00	FNH00-20K-A	20	16	240	3,2	10687494
		FNH00-25K-A	25	19	255	3,5	10701722
		FNH00-35K-A	35	23	430	5	10701721
		FNH00-40K-A	40	56	580	7	10702117
		FNH00-50K-A	50	130	1.430	9	10701718
		FNH00-63K-A	63	180	2.170	10,5	10705764
		FNH00-80K-A	80	270	2.710	13,5	10705995
		FNH00-100K-A	100	400	4.530	14	10707110
		FNH00-125K-A	125	810	6.350	16,5	10707231
		FNH00-160K-A	160	2.100	15.270	22,5	10701724
		FNH00-200K-A	200	2.900	25.870	26,5	10710732
FNH00-250K-A	250	6.200	43.980	30,5	10711445		
	1	FNH1-63K-A	63	63	770	15	10806688
		FNH1-80K-A	80	175	1.610	19	10807549
		FNH1-100K-A	100	320	3.050	21	10807553
		FNH1-125K-A	125	695	6.360	25	10807554
		FNH1-160K-A	160	1.460	13.090	29,5	10808545
		FNH1-200K-A	200	2.420	16.380	34,5	10809133
		FNH1-250K-A	250	4.920	29.810	40,5	10809489
		FNH1-315K-A	315	7.310	39.590	48	10809575
		FNH1-350K-A	350	11.430	64.870	52	10814896
	2	FNH2-250K-A	250	3.390	24.370	45,5	10823581
		FNH2-315K-A	315	4.760	32.780	57,5	10823936
		FNH2-350K-A	350	7.990	60.150	66,5	10823996
		FNH2-400K-A	400	14.850	92.060	77	10824053
		FNH2-450K-A	450	18.420	132.990	91	10824055
		FNH2-500K-A	500	23.040	146.250	103	10824109
		FNH2-630K-A	630	49.130	298.820	127	10824110
		FNH2-710K-A	710	57.910	378.450	137,5	11393547
	3	FNH3-400K-A	400	6.520	66.830	70	10831217
		FNH3-450K-A	450	15.090	105.220	74,5	10832962
		FNH3-500K-A	500	18.770	107.200	79,5	10833056
		FNH3-630K-A	630	32.500	222.540	94	10833101
		FNH3-710K-A	710	56.620	308.900	105	10833591
		FNH3-800K-A	800	87.390	420.500	117	10833726
		FNH3-900K-A	900	129.380	636.150	130	11393564
		FNH3-1000K-A	1.000	197.890	893.350	150	11393565

Nota: para instalación del fusible en base fusible BNH y llave seccionadora FSW/RFW considerar la tabla de factores de reducción de corriente de la pág. 15.

Factores de reducción para I <sup>2</sup> t en tensiones inferiores a 690 V ca	
Tensión V ca	Factor a ser aplicado
127	0,43
220	0,43
254	0,45
266	0,46
277	0,48
300	0,50
345	0,53
400	0,58
440	0,62
460	0,64
480	0,68

Nota: para otros valores de tensión utilizar la curva "variación I<sup>2</sup>t x tensión de trabajo" de la pág. 14.

# Fusibles Clase aR - Tipo NH Contacto Cuchilla

## Accesorios

### Base Fijación Fusible NH Contacto Cuchilla (aR)



Referencia	Tamaño	Código
BNH00-160	000 y 00	10409904
BNH1-250	1	10409905
BNH2-400	2	10185938
BNH3-630	3	10185939

### Placa Divisoria

PDNH00



PDNH1  
PDNH2  
PDNH3

Referencia	Tamaño	Código
PDNH00	000 y 00	10185940
PDNH1	1	10185941
PDNH2	2	10185942
PDNH3	3	10185943

## Montaje de las Bases con Placas Divisorias

### FNH1 / FNH2 / FNH3

- PDNH1: montaje tipo FNH1 sin distanciador
- PDNH2: montaje tipo FNH2 con 1 distanciador
- PDNH3: montaje tipo FNH3 con 3 distanciadores/ placa divisoria

Placa divisoria

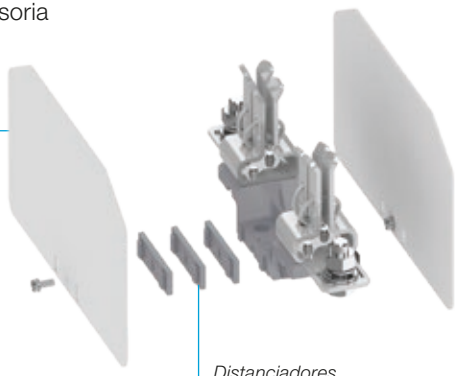

Distanciadores

Base

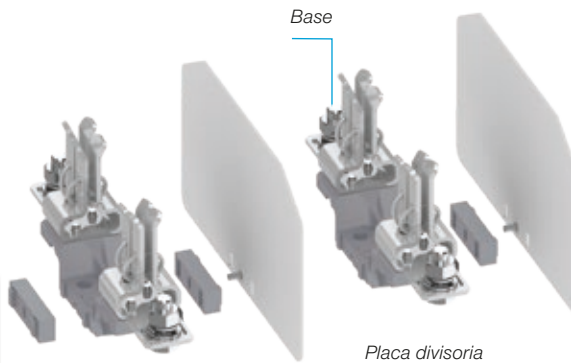

Placa divisoria

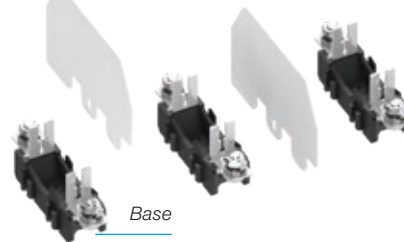

Base

### FNH000 / FNH00

Las bases BNH00 deberán estar encajadas solamente cuando se utilicen las placas divisorias PDNH00. En ambas formas de montaje es indispensable mantener un alejamiento de 25 mm entre las partes vivas de los fusibles y los equipos adyacentes.





## Accesorios

### Puño Sacafusible NH Contacto Cuchilla



Referencia	Código
PSFNH	10185944

## Dimensiones

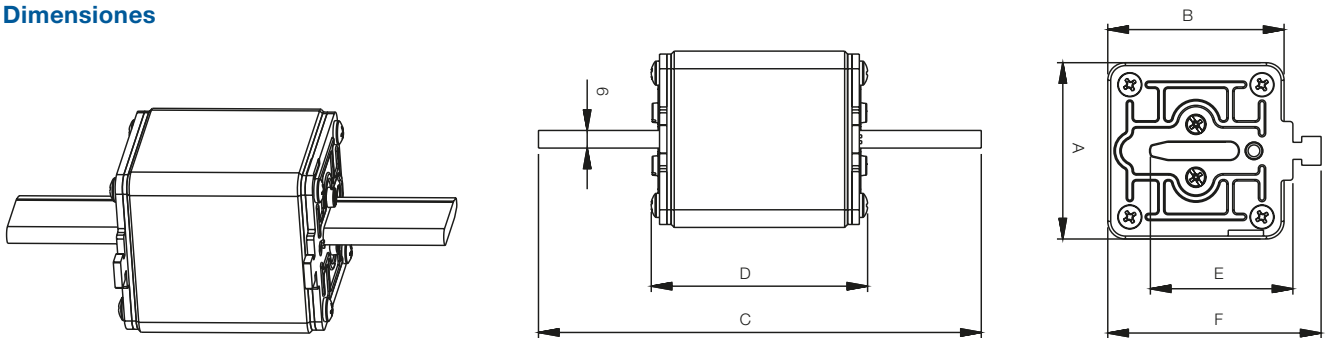

Clase	Tamaño	Rango de corriente (A)	A (mm)	B (mm)	C (mm)	D (mm)	E (mm)	F (mm)
aR	000	20 a 125	20,5	40	78,5	54	35	51
	00	20 a 250	29,5	47,5	78,5	54	35	59,5
	1	63 a 400	51,5	51,5	135	73	40	63,5
	2	250 a 710	60	60	150	73	48	72,5
	3	400 a 1.000	73,60	73,60	150	73	60	87,5



# Fusibles Clase aR - Tipo NH Contacto Cuchilla

## Dimensiones

### Base para Fusible BNH y Placas Divisorias PDNH

BNH00 + FNH00 + PDNH00  
BNH00 + FNH000 + PDNH00

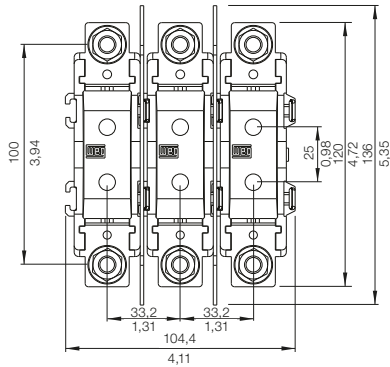

BNH00 + FNH00 + PDNH00  
BNH00 + FNH000 + PDNH00

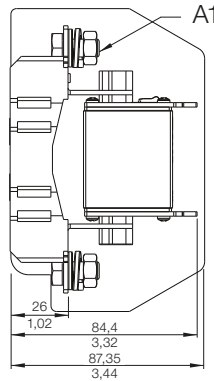

BNH00

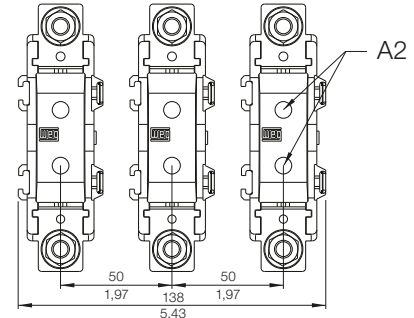

Es indispensable mantener una distancia de 25 mm entre las partes vivas de los fusibles y los equipos adyacentes.

BNH1 + PDNH1  
BNH2 + PDNH2  
BNH3 + PDNH3

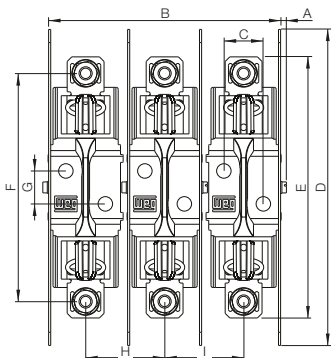

BNH1 + FNH1 + PDNH1  
BNH2 + FNH2 + PDNH2  
BNH3 + FNH3 + PDNH3

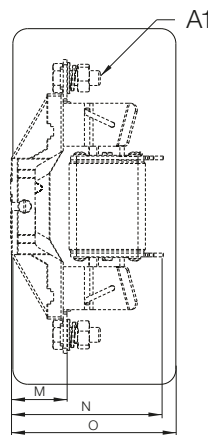

BNH1  
BNH2  
BNH3

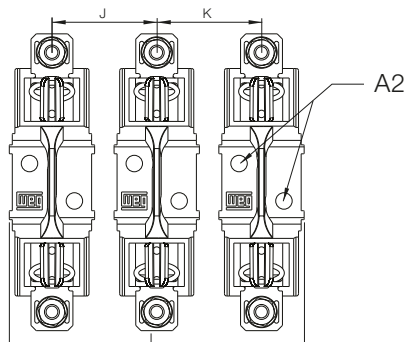

A1			N.M lb.in
BNH00	M8		10 88
BNH1	M10		21 185
BNH2	M10		21 185
BNH3	M12		38 336

A2			N.M lb.in
BNH00	M6		5 44
BNH1	M8		10 88
BNH2	M8		
BNH3	M8		

mm in	BNH1 + FNH1	BNH1 + FNH1 + PDNH1	BNH2 + FNH2	BNH2 + FNH2 + PDNH2	BNH3 + FNH3	BNH3 + FNH3 + PDNH3
A	3,5 0,14		3,5 0,14		3,5 0,14	
B	-	180 7,09	-	200,2 7,88	-	245 9,65
C	30 1,18					
D	240 9,45					
E	198,3 7,81		225 8,86		240 9,45	
F	173,3 6,82		200 7,87		210 8,27	
G	25 0,98					
H	-	60 2,36	-	70 2,76	-	85 3,35
I						
J	70 2,76		80 3,15		95 3,74	
K						
L	197 7,76		217 8,54		261 10,28	
M	38 1,50		38,5 1,52		39 1,54	
N	102 4,02		111,5 4,39		112 4,41	
O	111,5 4,39		115,5 4,55		132,8 5,23	

### Curvas Tiempo x Corriente

Las curvas tiempo x corriente proveen una representación gráfica del tiempo medio de fusión de los elementos de los fusibles a temperatura ambiente, también llamado de tiempo de prearco, con relación a la corriente rms presumida IP. Los fusibles FNH con contacto cuchilla aR no pueden actuar arriba del tiempo de 30 segundos, representado por la línea AA'. Es necesaria la utilización de dispositivos de protección contra sobrecarga, para evitar la condición por encima de la curva AA' sobre el fusible.

**Fusibles FNH00 aR**

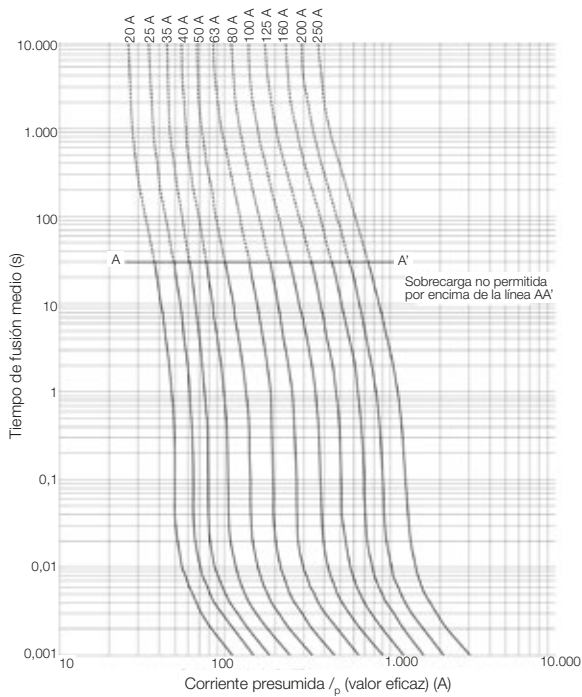

**Fusibles FNH000 aR**

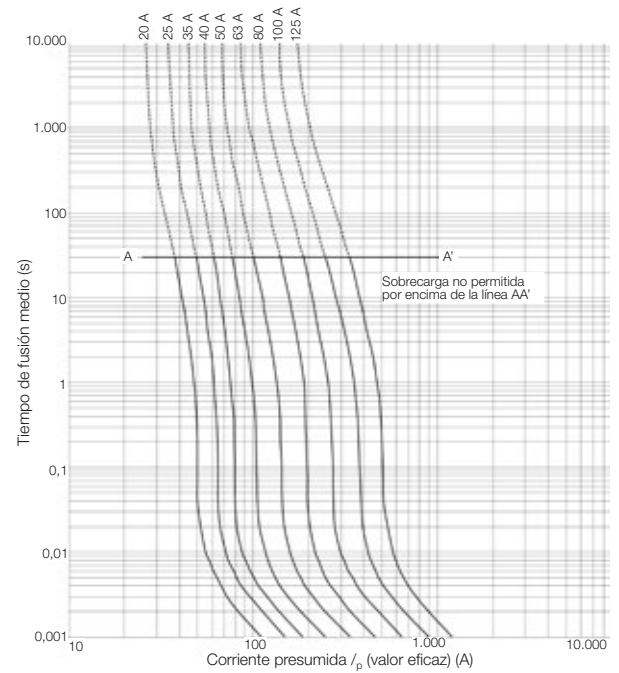

**Fusibles FNH1 aR**

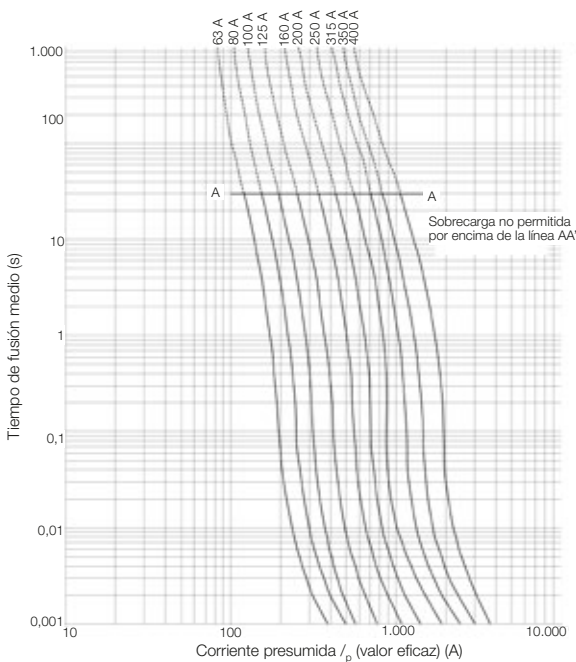

**Fusibles FNH2 aR**

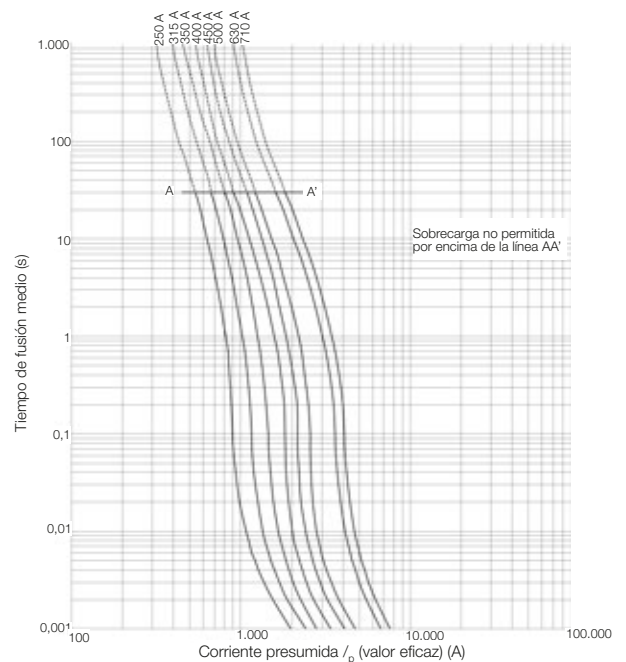

# Fusibles Clase aR - Tipo NH Contacto Cuchilla

## Curvas Tiempo x Corriente

### Fusibles FNH3 aR

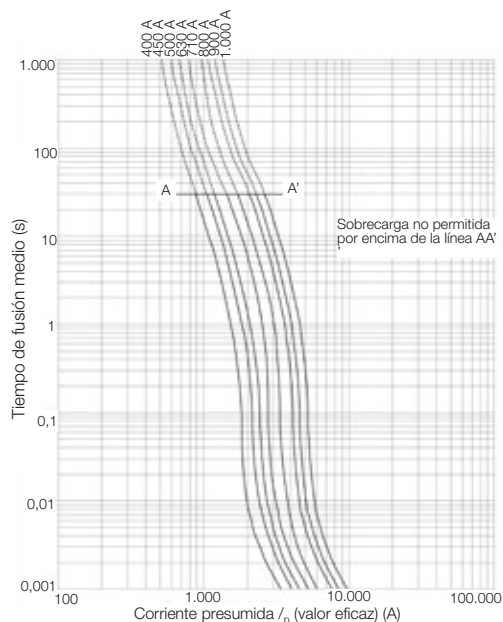

## Curva de Limitación de Corriente

Las curvas de limitación de corriente informan la corriente de pico máxima que circulará a través del fusible durante su actuación, con relación al valor eficaz de corriente presumida de cortocircuito.

### Fusibles FNH00 aR

- 1 - Corriente de cortocircuito simétrica  $I_c = \sqrt{2} I_p$
- 2 - Corriente de cortocircuito asimétrica  $I_c = 2,5 I_p$

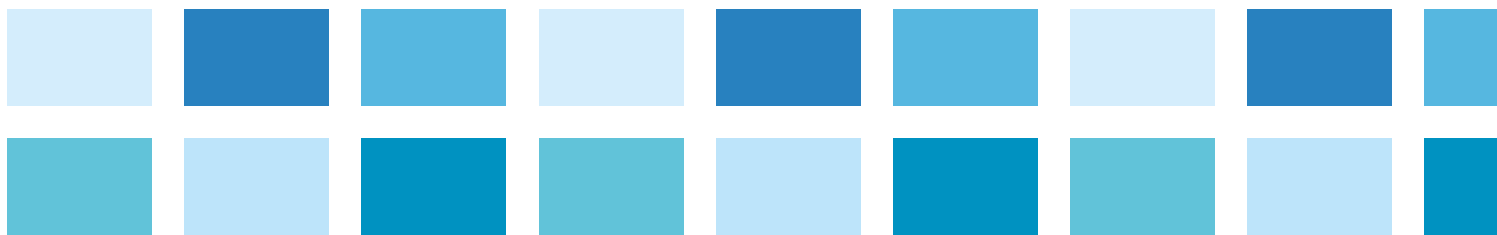
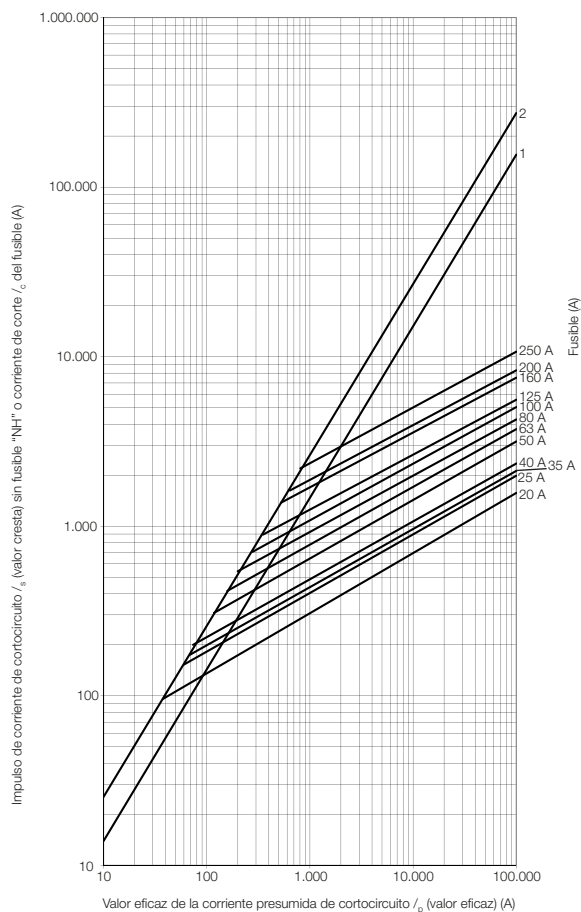

### Curva de Limitación de Corriente

#### Fusibles FNH000 aR

- 1 - Corriente de cortocircuito simétrica
- 2 - Corriente de cortocircuito asimétrica

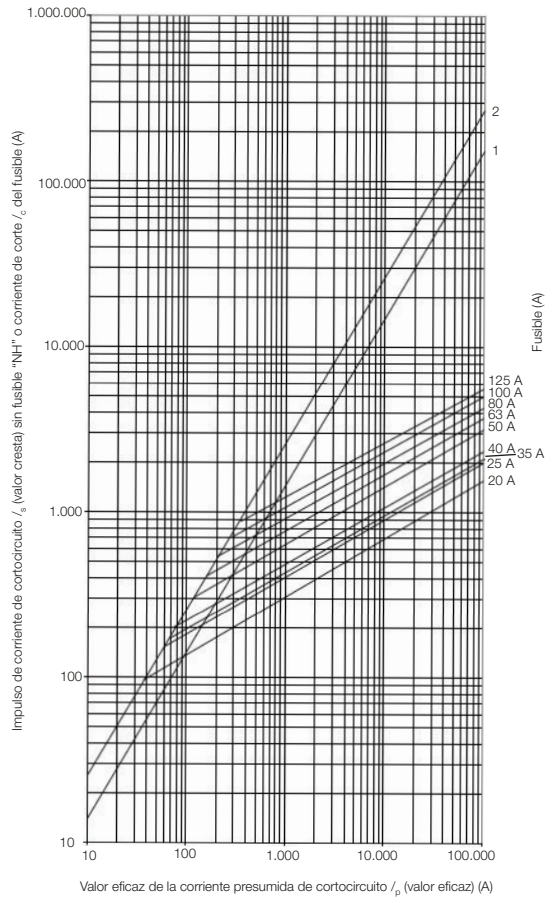

#### Fusibles FNH1 aR

- 1 - Corriente de cortocircuito simétrica  $I_c = \sqrt{2} I_p$
- 2 - Corriente de cortocircuito asimétrica  $I_c = 2,5 I_p$

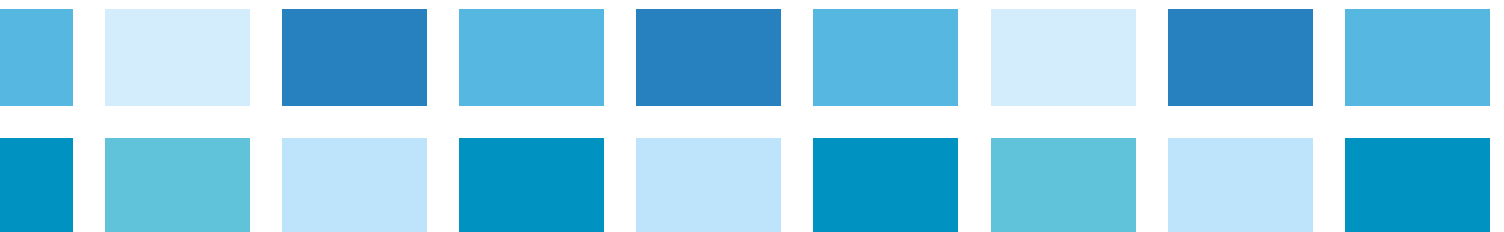
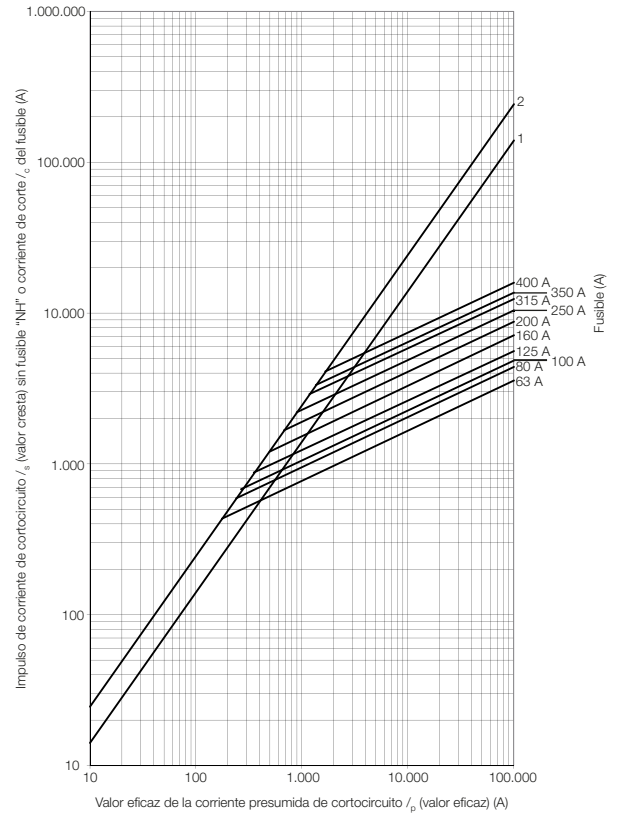

# Fusibles Clase aR - Tipo NH Contacto Cuchilla

## Curva de Limitación de Corriente

### Fusibles FNH2 aR

- 1 - Corriente de cortocircuito simétrica  $I_c = \sqrt{2} I_p$
- 2 - Corriente de cortocircuito asimétrica  $I_c = 2,5 I_p$

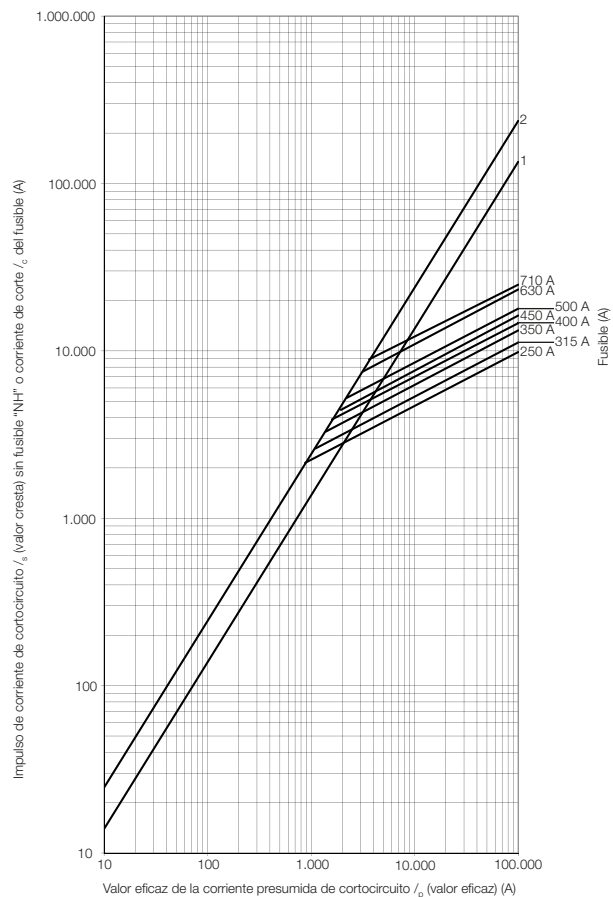

### Fusibles FNH3 aR

- 1 - Corriente de cortocircuito simétrica  $I_c = \sqrt{2} I_p$
- 2 - Corriente de cortocircuito asimétrica  $I_c = 2,5 I_p$

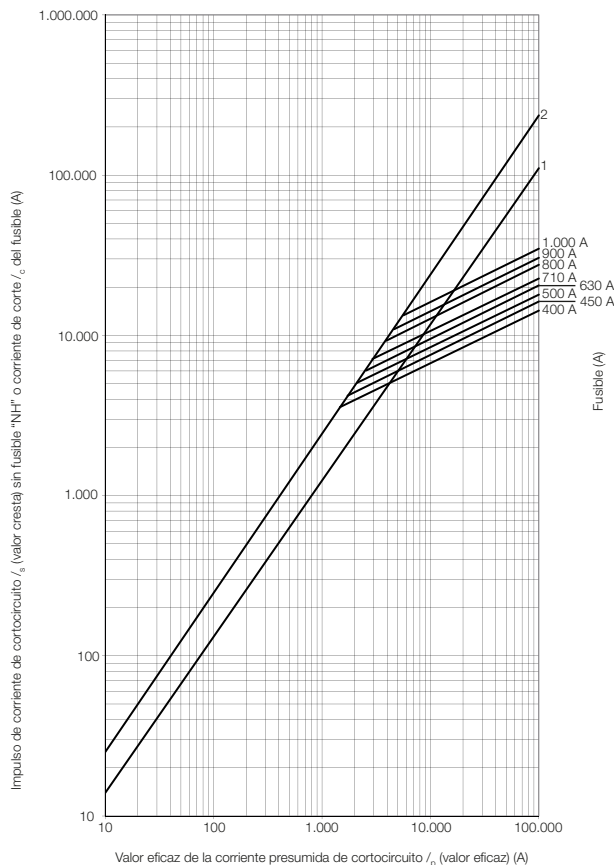

### Variación de I<sup>2</sup>t Total x Tensión de Trabajo

Los valores de I<sup>2</sup>t presentados son referenciados para tensión 690 V ca. Para otras tensiones el I<sup>2</sup>t varía conforme la tabla a seguir:

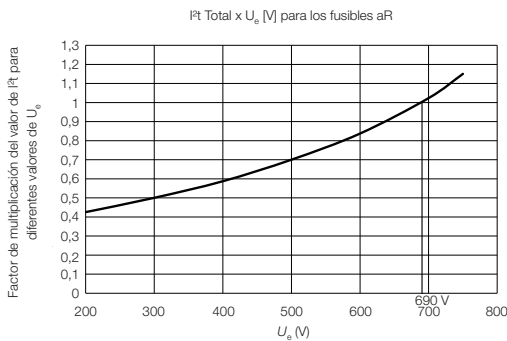

Nuevo I<sup>2</sup>t total en función de la tensión aplicada  
= factor multiplicación x I<sup>2</sup>t total del fusible

### Coefficiente Multiplicador para Calcular Potencia de Pérdida

La curva determina el coeficiente multiplicador para calcular la potencia de pérdida del fusible para diferentes múltiplos de corriente nominal.

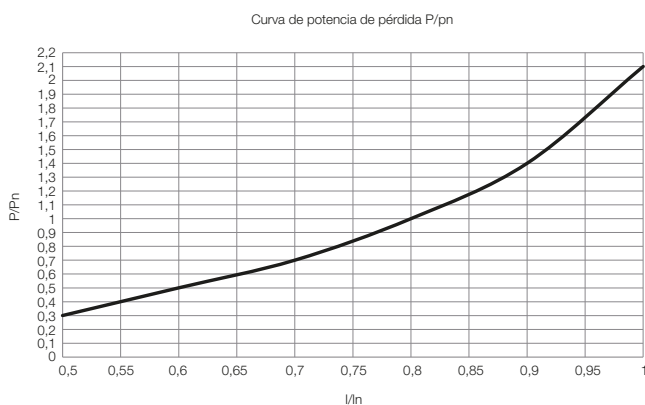

### Aplicación en Corriente Continua - Definición de la Tensión de Trabajo del Fusible

La curva indica el factor de multiplicación de la tensión nominal V ca del fusible para la obtención del valor máximo de tensión V cc para diferentes valores de constantes de tiempo L/R (ms) del circuito.

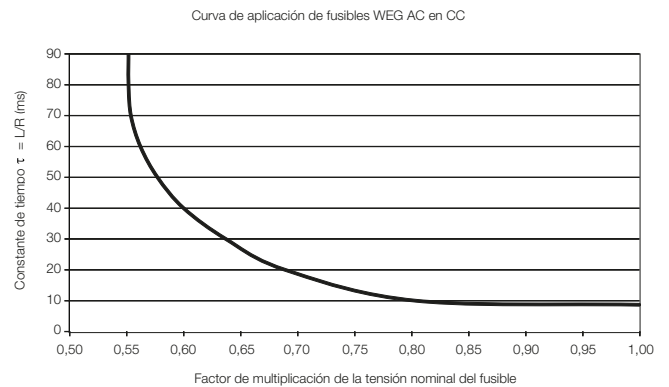

V cc = "factor de multiplicación" x 690 V ca

### Curva de Tensión de Arco

Durante la interrupción de la corriente de falta, en cada restricción del elemento surgirá un arco eléctrico, generando consecuentemente una tensión de arco. El valor de la tensión de arco de los fusibles varía con la tensión de trabajo del fusible.

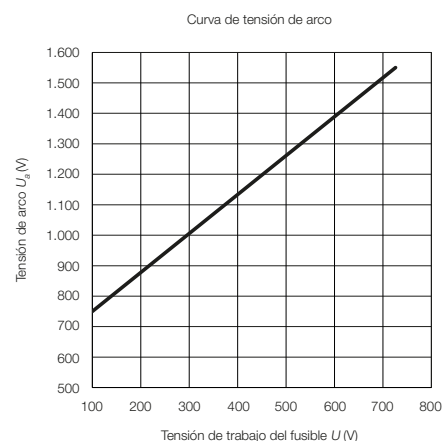

## Fusibles Clase aR - Tipo NH Contacto Cuchilla

### Factores de Reducción para Uso de Fusibles aR tipo NH Contacto Cuchilla en Base Fusible BNH o Seccionadoras FSW y RFW

Debido a la elevada potencia disipada por los fusibles aR, es necesario aplicar el múltiplo "factor de reducción" que determina la máxima corriente permisible para el fusible WEG FNH aR con contacto cuchilla montado en la base de fijación individual o en la llave seccionadora.

Factores de reducción para uso de fusibles aR NH tipo cuchilla en base fusible BNH o seccionadoras FSW y RFW								
Referencia del fusible aR	Tamaño del fusible	Corriente nominal del fusible $I_n$ (A)	Factor de reducción					
			Para instalación en base fusible - BNH		Para instalación en llave seccionadora FSW o RFW			
			Factor de reducción	Referencia base fusible	Factor (FSW)	Referencia FSW	Factor (RFW)	Referencia RFW
FNH000-20K-A	000	20	1,00	BNH00-160 (10409904)	1,00	FSW100-3 11884107	1,00	RFW100-3 11884098
FNH000-25K-A		25	1,00		1,00		1,00	
FNH000-35K-A		35	1,00		1,00		1,00	
FNH000-40K-A		40	1,00		1,00		0,90	
FNH000-50K-A		50	1,00		0,90		0,80	
FNH000-63K-A		63	1,00		0,85		0,75	
FNH000-80K-A		80	0,90		0,70		0,60	
FNH000-100K-A		100	0,85		0,70		0,60	
FNH000-125K-A		125	0,80		0,65		0,55	
FNH00-20K-A	00	20	1,00	BNH00-160 (10409904)	1,00	FSW160-3 (11884182)	1,00	RFW160-3 (11884099)
FNH00-25K-A		25	1,00		1,00		1,00	
FNH00-35K-A		35	1,00		1,00		1,00	
FNH00-40K-A		40	1,00		1,00		1,00	
FNH00-50K-A		50	1,00		1,00		1,00	
FNH00-63K-A		63	1,00		1,00		1,00	
FNH00-80K-A		80	1,00		0,95		0,95	
FNH00-100K-A		100	1,00		0,90		0,90	
FNH00-125K-A		125	1,00		0,85		0,85	
FNH00-160K-A		160	0,90		0,75		0,75	
FNH00-200K-A		200	0,85		0,70		0,70	
FNH00-250K-A	250	0,80	0,60	0,60				
FNH1-63K-A	1	63	1,00	BNH1-250 (10409905)	0,95	FSW250-3 (11884179)	0,95	RFW250-3 (11884100)
FNH1-80K-A		80	0,95		0,85		0,85	
FNH1-100K-A		100	0,95		0,85		0,85	
FNH1-125K-A		125	0,90		0,80		0,80	
FNH1-160K-A		160	0,85		0,75		0,75	
FNH1-200K-A		200	0,80		0,70		0,70	
FNH1-250K-A		250	0,75		0,70		0,70	
FNH1-315K-A		315	0,75		0,65		0,65	
FNH1-350K-A		350	0,70		0,65		0,65	
FNH1-400K-A	400	0,70	0,60	0,60				
FNH2-250K-A	2	250	0,90	BNH2-400 (10185938)	0,80	FSW400-3 (11884180)	0,80	RFW400-3 (11884101)
FNH2-315K-A		315	0,90		0,80		0,80	
FNH2-350K-A		350	0,85		0,75		0,75	
FNH2-400K-A		400	0,80		0,70		0,70	
FNH2-450K-A		450	0,80		0,70		0,70	
FNH2-500K-A		500	0,75		0,65		0,65	
FNH2-630K-A		630	0,70		0,60		0,60	
FNH2-710K-A	710	0,70	0,55	0,55				
FNH3-400K-A	3	400	0,80	BNH3-630 (10185939)	0,75	FSW630-3 (11884181)	0,75	RFW630-3 (11884103)
FNH3-450K-A		450	0,80		0,75		0,75	
FNH3-500K-A		500	0,75		0,70		0,70	
FNH3-630K-A		630	0,75		0,65		0,65	
FNH3-710K-A		710	0,75		0,65		0,65	
FNH3-800K-A		800	0,75		0,60		0,60	
FNH3-900K-A		900	0,70		0,55		0,55	
FNH3-1000K-A	1.000	0,70	0,55	0,55				

Ejemplos: Cómo calcular la máxima corriente de carga (régimen continuo) en el fusible:

Considerando que el fusible dimensionado sea el modelo FNH2-630K-A (630 A, tamaño 2).

Opción 1 - instalado en BNH2-400.

La máxima corriente en régimen continuo soportada por el fusible será de  $630 A \times 0,7 = 441 A$ .

Opción 2 - instalado en interruptor-seccionador SW400-3.

La máxima corriente en régimen continuo soportada por el fusible será de  $630 A \times 0,6 = 378 A$ .

Opción 3 - instalado en interruptor-seccionador con fusible incorporado.

La máxima corriente en régimen continuo soportada por el fusible será de  $630 A \times 0,6 = 378 A$ .





## Fusibles Clase aR - Tipo NH Flush End

### Características Técnicas

Los fusibles aR ultrarrápidos tipo NH flush end son montados en cuerpo cerámico de alta calidad. Poseen llenado con arena de cuarzo impregnada, elemento fusible en plata pura y conexiones en cobre plateado, proporcionando excelente aislamiento eléctrico, rigidez mecánica, resistencia contra shocks térmicos durante la actuación del fusible y valores de  $I^2t$  reducidos. Su estructura es preparada para fijación directamente en barramientos de cobre, no necesitando el uso de base de fijación individual del interruptor-seccionador.

### 200 kA / 690 V ca

Características técnicas de los fusibles FNH aR flush end							
Referencia	Tamaño	Corriente $I_n$ (A)	$I^2t$ pre-arco (A <sup>2</sup> s)		Potencia disipada (W) $1xI_n$	Código	
			660 V ca (A <sup>2</sup> s)				
FNH3FEM-450Y-A	3	450	32.000	94.500	115	12644962	
FNH3FEM-500Y-A		500	40.000	129.000	115	12645317	
FNH3FEM-550Y-A		550	66.500	177.000	120	12660187	
FNH3FEM-630Y-A		630	84.000	227.000	120	12660583	
FNH3FEM-700Y-A		700	100.000	309.000	125	12660657	
FNH3FEM-800Y-A		800	140.500	470.000	135	12661660	
FNH3FEM-900Y-A		900	180.000	650.000	135	12661662	
FNH3FEM-1000Y-A		1.000	239.500	890.000	145	12661663	
NH3FEM-1100Y-A		1.100	292.000	1.340.000	150	12661664	
FNH3FEM-1250Y-A		1.250	385.000	1.970.000	155	12661665	
FNH3FEM-1400Y-A		1.400	500.000	2.680.000	215	12661666	
FNH23FEA-1000Y-A		23	1.000	151.000	446.000	230	12644745
FNH23FEA-1250Y-A			1.250	213.000	822.000	250	12661667
FNH23FEA-1400Y-A	1.400		279.000	1.050.000	270	12661688	
FNH23FEA-1600Y-A	1.600		360.000	1.760.000	295	12661689	
FNH23FEA-1800Y-A	1.800		529.000	2.430.000	320	12661690	
FNH23FEA-2000Y-A	2.000		710.000	3.170.000	365	12661692	

## Fusibles Clase aR - Tipo NH Flush End

### Accesorios

#### Contacto Auxiliar Fusible Flush End

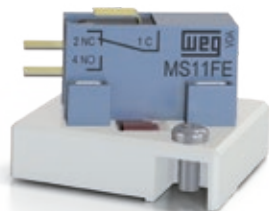

Referencia	Descripción	Código
MS11FE	Microswitch Fusible Flush End MS11FE	12626734



Características técnicas MS11FE			
Contactos auxiliares	1NC y 1NA		
Tensión nominal ( $U_n$ )	250 V ca		
Corriente nominal ( $I_n$ )	15 A		
Datos técnicos del microswitch WEG MS11FE			
Capacidad de interrupción	Carga resistiva	250 V ca @ 50/60 Hz	15 A
		8 V cc	15 A
		30 V cc	10 A
		125 V cc	0,6 A
		250 V cc	0,3 A
	Carga inductiva <sup>1)</sup>	250 V ca @ 50/60 Hz	10 A
		8 V cc	10 A
		30 V cc	10 A
		125 V cc	0,6 A
		250 V cc	0,3 A
Rigidez dieléctrica	Entre terminales no continuos	1.000 V ca	
-	Entre terminales y circuito de potencia	1.500 V ca	
Mínima tensión / corriente admisible - IEC 60947-5-4	20 V / 50 mA		
Grado de protección conforme IEC 60529	IP00		
Inflamabilidad conforme UL 94	UL 94		
Terminales	Faston #187		

Nota: factor de potencia 0,4 min. (V ca) y constante de tiempo 7ms máx. (V cc).

### Dimensiones

#### FNH3FEM

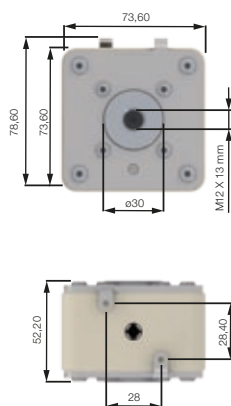

Masa: 820 g

#### FNH23FEA



Masa: 1.970 g

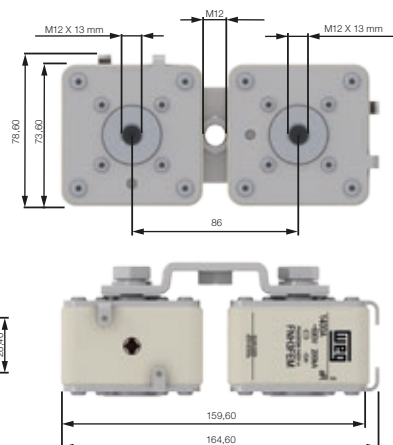

### Curvas Tiempo x Corriente

Las curvas tiempo x corriente proveen una representación gráfica del tiempo medio de fusión de los elementos de los fusibles en la temperatura ambiente, también llamado de tiempo de prearco, con relación a la corriente rms presumida IP. Los fusibles FNH tipo flush end no pueden actuar por encima del tiempo de 30 segundos, representado por la línea AA'. Es necesaria la utilización de dispositivos de protección contra sobrecarga, para evitar la condición por encima de la curva AA' sobre el fusible.

#### Fusibles FNH3FEM

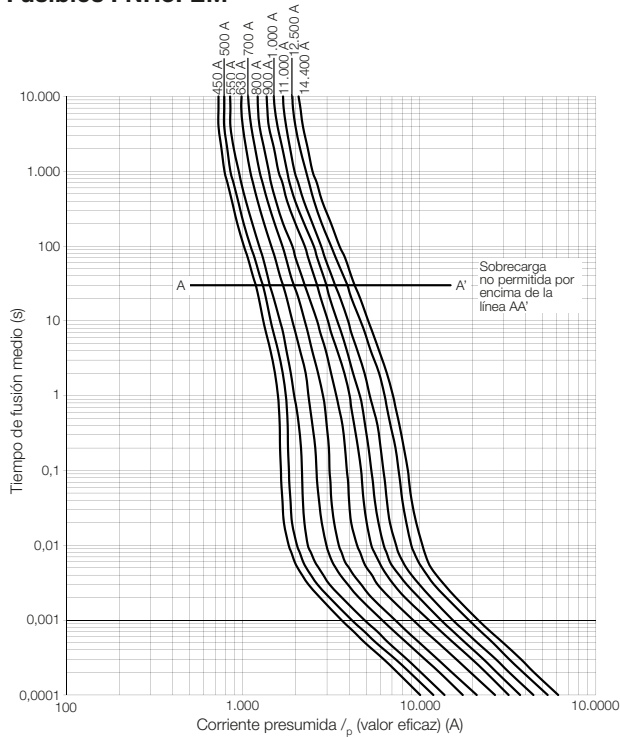

#### Fusibles FNH23FEA

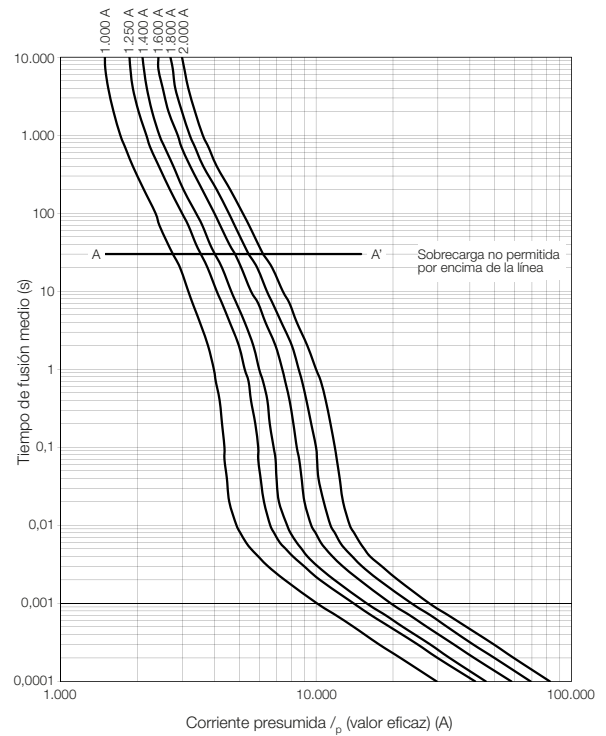

### Curvas de Limitación de Corriente

Las curvas de limitación de corriente informan la corriente de pico máxima que circulará a través del fusible, durante su actuación, con relación al valor eficaz de corriente presumida de cortocircuito.

#### Fusibles FNH3FEM

- 1 - Corriente de cortocircuito simétrica  $I_c = \sqrt{2} I_p$
- 2 - Corriente de cortocircuito asimétrica  $I_c = 2,5 I_p$

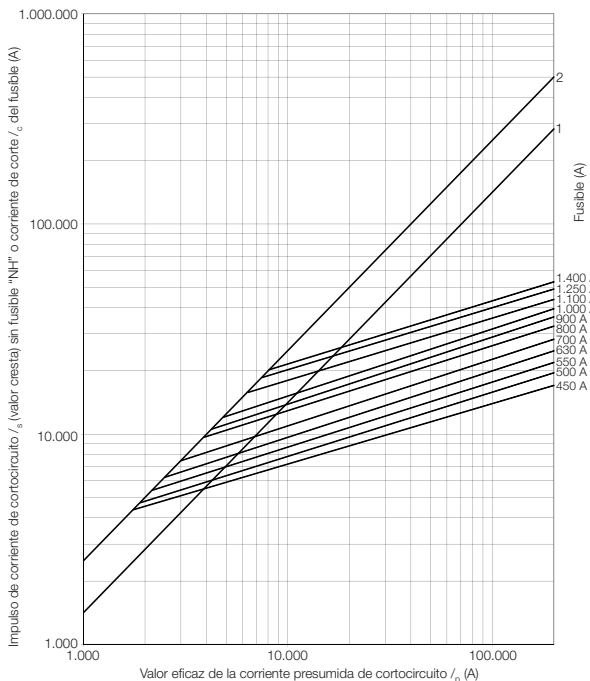

#### Fusibles FNH23FEA

- 1 - Corriente de cortocircuito simétrica  $I_c = \sqrt{2} I_p$
- 2 - Corriente de cortocircuito asimétrica  $I_c = 2,5 I_p$

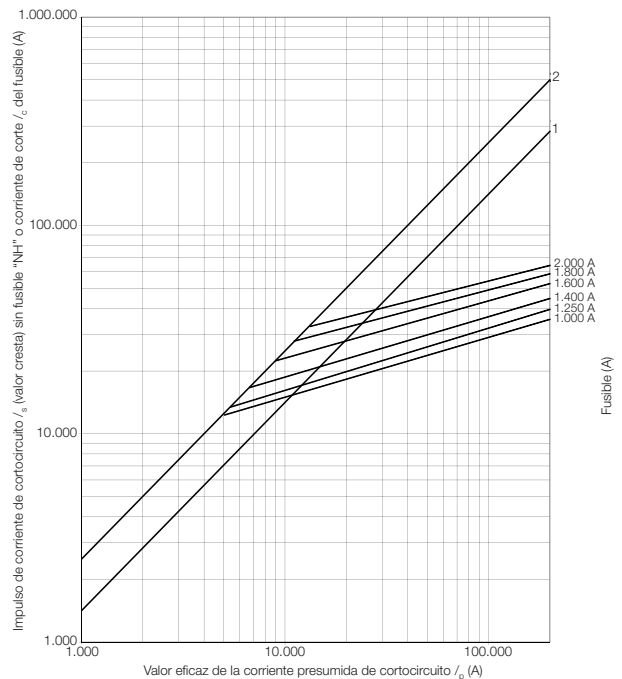

## Fusibles Clase aR - Tipo NH Flush End

### Variación de I<sup>2</sup>t Total x Tensión de Trabajo

Los valores de I<sup>2</sup>t presentados son referenciados para tensión 660 V ca. Para otras tensiones el I<sup>2</sup>t disminuye conforme los factores de la tabla a seguir.

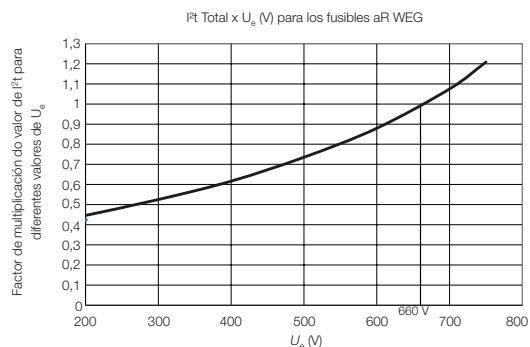

### Aplicación en Corriente Continua - Definición de la Tensión de Trabajo del Fusible

La curva indica el factor de multiplicación de la tensión nominal V ca del fusible para la obtención del valor máximo de tensión V cc para diferentes valores de constantes de tiempo L/R (ms) del circuito

$$V_{cc} = \text{"factor de multiplicación"} \times 690 \text{ V ca}$$

### Curva de Aplicación de Fusibles WEG CA en CC

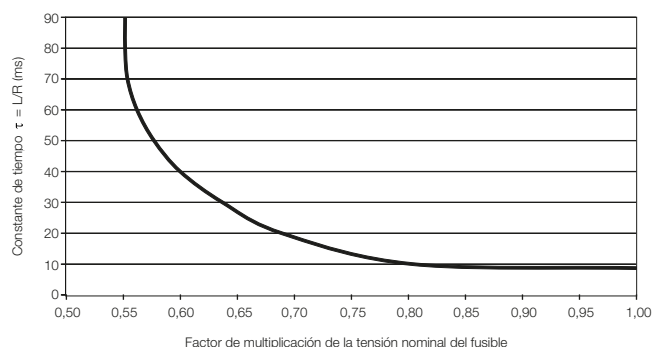

### Coefficiente Multiplicador para Calcular Potencia de Pérdida

La curva determina el coeficiente multiplicador para calcular la potencia de pérdida del fusible para diferentes múltiplos de corriente nominal.

### Curva de Potencia de Pérdida P/Pn

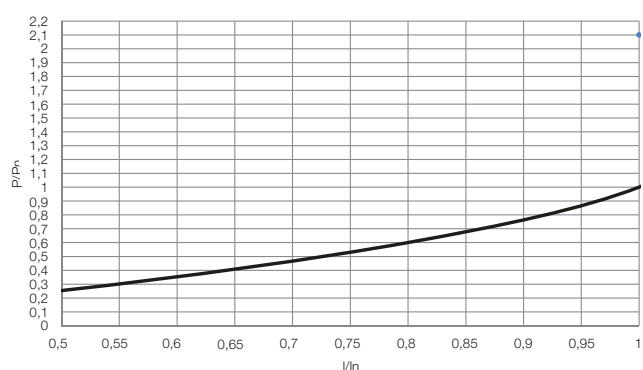

### Curva de Tensión de Arco

Durante la interrupción de la corriente de falta, en cada restricción del elemento surgirá un arco eléctrico, generando consecuentemente una tensión de arco. El valor de la tensión de arco de los fusibles varía con la tensión de trabajo del fusible.

### Curva de Tensión de Arco

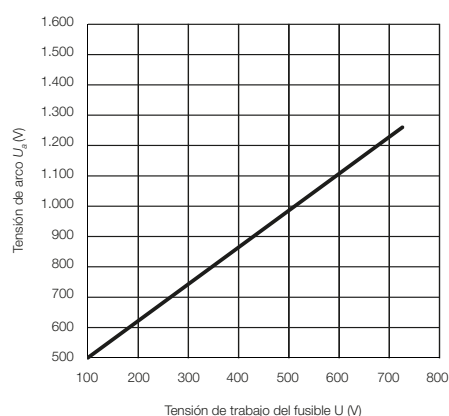

### Aplicación en Corriente Continua - Definición de Tensión de Trabajo del Fusible

La curva indica el factor de multiplicación de tensión nominal  $V_{ca}$  del fusible para la obtener el valor máximo de tensión  $V_{cc}$  para diferentes valores de constantes de tiempo  $L/R$  (rms) del circuito.

#### Curva de aplicación de fusibles WEG CA en CC

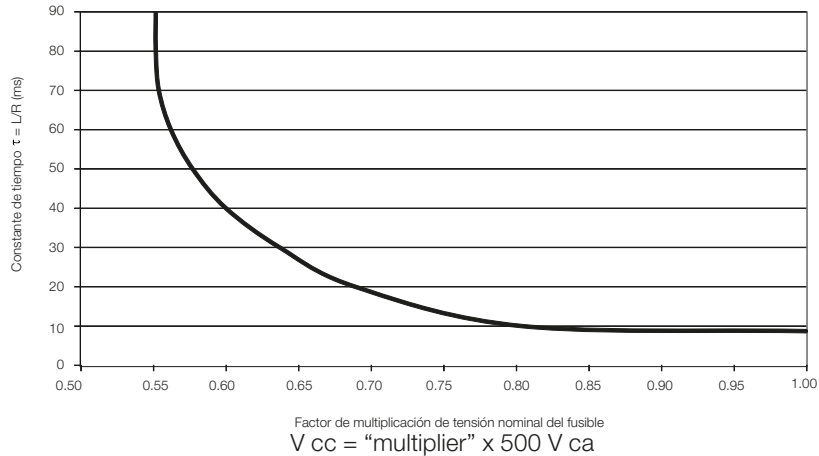

### Temperatura del Ambiente

Los fusibles aR WEG son dimensionados para operar en ambientes con temperatura de  $25 \pm 5$  °C. Fusibles aplicados en ambientes de diferentes temperaturas poseen diferentes tasas de disipación de calor, causando la reducción o el incremento de su corriente nominal. Debido a esto, el factor  $T_a$  debe ser aplicado en el dimensionamiento de los fusibles WEG, clases aR.

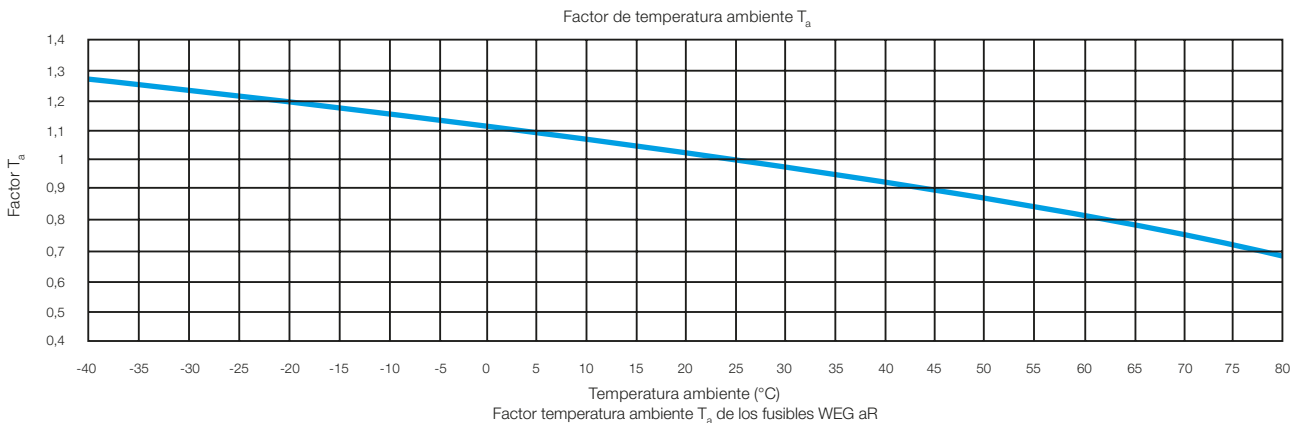

### Altitud

La instalación de los fusibles aR WEG no debe exceder los 2.000 metros por encima del nivel del mar, conforme la IEC 60269. Por encima de esta altitud, la baja presión atmosférica influencia directamente en la disipación térmica del fusible. Debido a esto, el factor  $K_{alt}$  debe ser aplicado en el dimensionamiento de los fusibles WEG, clases aR.

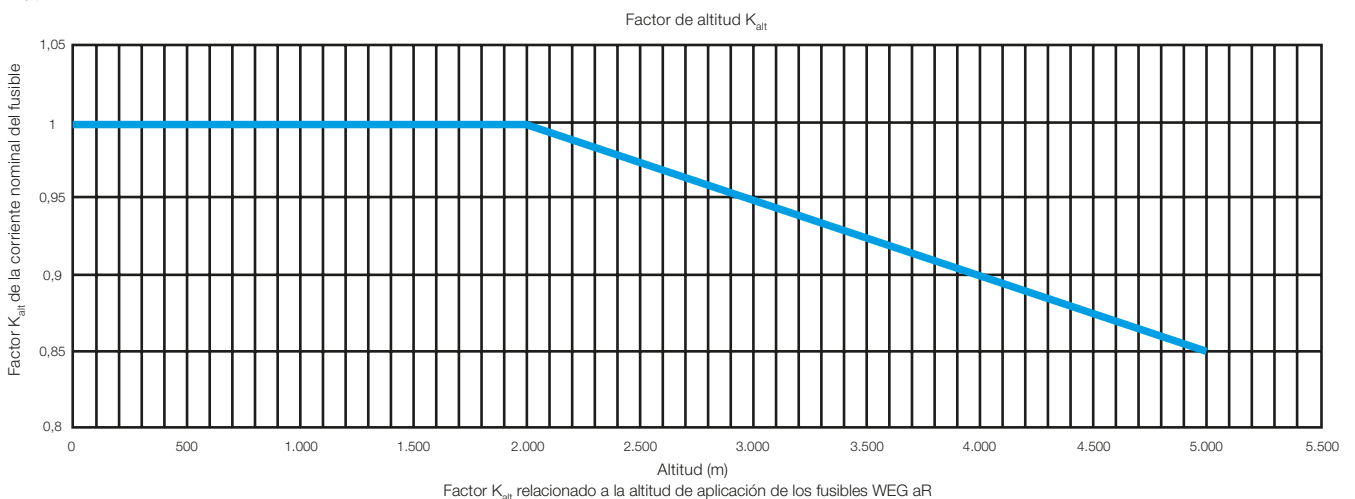

# Anexo 1: Criterios de Dimensionamiento Fusibles Ultrarrápidos aR Contacto Cuchilla y Flush End

## 1. Conceptuación

Los fusibles clase aR, de acuerdo con la norma IEC 60269 tienen como característica bajos valores de  $I^2t$  y se aplican en la protección de semiconductores contra cortocircuito. Debido a esto, no deben ser aplicados en situaciones de pequeñas sobrecargas, ya que en estas condiciones pueden ocurrir sobrecargas térmicas sobre el fusible, causando su actuación indebida y la reducción de su capacidad de interrupción.

Por este motivo, el fusible aR WEG utiliza una constante de carga  $A = 0,8$ . O sea, la corriente nominal del fusible debe ser al menos 20% mayor que la corriente nominal del circuito.

## 2. Dimensionamiento

Varias condiciones influyen en la capacidad de conducción de corriente de un fusible, como por ejemplo, la temperatura ambiente, la ventilación forzada y la sección transversal de los barramientos o cables. Vale destacar que cargas cíclicas de sobrecargas son la condición más determinante que puede causar la quema prematura del fusible.

Equipos que incorporan dispositivos semiconductores y, consecuentemente, fusibles ultrarrápidos, son frecuentemente sometidos a las sobrecargas repetitivas, o cíclicas. Bajo esta condición, se eleva la temperatura de los elementos del fusible y, dependiendo de eventuales sobrecargas, se puede alcanzar la temperatura de fusión del material que constituye los elementos o fatigar éstos, causando una operación indebida. Para evitar las consecuencias de las sobrecargas cíclicas, se debe dimensionar el fusible aR WEG para que su corriente de fusión preferentemente sea, para el mismo período de duración de la sobrecarga, mayor que la corriente de ésta, conforme la Tabla 1, a seguir.

Tipo de conexión del fusible aR	Modelo	Múltiplos que la corriente de fusión del fusible aR WEG debe ser mayor que la corriente de sobrecarga para lo mismo tiempo de duración de la misma
Contacto cuchilla	FNH00	2,0
	FNH1	2,5
	FNH2	
	FNH3	
Flush end	FNH3FEM	2 <sup>1)</sup>
	FNH23FEA	

Tabla 1 - Múltiplos que la corriente de fusión del fusible aR WEG debe ser mayor que la corriente de sobrecarga para lo mismo tiempo de duración de la misma.

Nota: 1) Utilizar el múltiplo 1,6 para Soft-Starters WEG.

Ejemplo: una carga de corriente nominal  $I_n = 150$  A, en la cual frecuentemente ocurren sobrecargas de 450 A con 5 segundos de duración, se debe dimensionar el fusible para que posea, por lo menos, una corriente de fusión de 900 A en 5s para el tamaño 00, o una corriente de 1.125 A en 5s para los tamaños 1, 2 o 3.

De modo general, para un correcto dimensionamiento de fusible aR, deben ser analizados y cumplidos los siguientes criterios:

- **Tipo de corriente del circuito - alterna o continua.** Para circuito CC la máxima tensión sobre el fusible debe respetar la curva característica de aplicación de fusible WEG en corriente continua - ver catálogo "Fusibles aR y gL/gG".
- **$I^2t$  del fusible debe ser menor que el valor de  $I^2t$  del semiconductor.** Para este análisis se debe considerar el valor de  $I^2t$  del fusible, con relación a la tensión aplicada sobre éste - ver catálogo "Fusibles aR y gL/gG" y el valor recomendado por el fabricante del semiconductor.
- **La corriente nominal del fusible.** La corriente nominal del fusible WEG aR debe ser al menos 20% mayor que la corriente nominal de la carga para las condiciones en que no ocurran cargamentos cíclicos. En estos casos se deben observar también los valores de reducción de corriente para los fusibles aplicados en bases individuales y/o llaves seccionadoras. Para las condiciones en que hay cargamentos cíclicos, como por ejemplo aplicación de arrancadores suaves y convertidores de frecuencia, el dimensionamiento del fusible WEG aR debe seguir las especificaciones de la tabla 1 de arriba.
- **Instalación fusible aR contacto cuchilla en base para fusible BNH o interruptores-seccionadores FSW o RFW.** El valor de corriente en régimen continuo aplicado en el fusible aR tipo NH no debe ser mayor que los valores "reducidos" para uso en base fusible o Interruptor-seccionador - ver tabla "Factores de reducción de corriente para instalación de fusibles aR en base fusible BNH y llave seccionadora SFW" en el catálogo "Fusibles aR y gL/gG".
- **Asociación de fusibles en paralelo.** Para esta utilización, además de cumplir las especificaciones descritas en los tópicos anteriores, los fusibles conectados en paralelo deben poseer las mismas características, es decir, deben poseer el mismo tamaño y el mismo rango de corriente nominal para evitar desequilibrios de carga. Los barramientos o cables deben poseer el mismo largo para igualar todas las impedancias del circuito.

El valor de  $I^2t$  de los fusibles conectados en paralelo es calculado por:

$I^2t// = I^2t \times n^2$ , donde:

$I^2t//$  - es el valor de  $I^2t$  del conjunto de fusibles iguales conectados paralelamente.

$I^2t$  - es el valor de  $I^2t$  del fusible individual, dimensionado conforme la tensión del circuito.

$n$  - es el número de fusibles iguales conectados paralelamente.

### 3. Ejemplos de Dimensionamiento

#### 3.1 - Arrancador Suave SSW06 (220 a 690 V ca) 130 A

Dimensionar un fusible aR WEG para proteger un arrancador suave SSW06 130 A, accionando una carga trifásica con las siguientes características:

- $I^2t$  máximo del fusible para proteger el SSW06 130 A: 63.000 A<sup>2</sup>s
- Tensión de la red: Y 690 V ca
- Corriente nominal de la carga en régimen constante:  $I_n = 100$  A
- Corriente en el arranque:  $I_p = 3 \times I_n = 300$  A
- Tiempo de aceleración: 30s

#### 3.2 - Corriente Nominal del Fusible

Análisis de la corriente nominal del fusible para el régimen constante: la corriente del fusible debe ser dimensionada a través de la ecuación de abajo, considerando:

- Corriente nominal de la carga = IRMS da carga = 100 A
- Para carga constante,  $A1 = 0,8$

$$\text{Luego: } I_n \geq \frac{I_{RMS \text{ de la carga}}}{A_1} = \frac{100}{0,8} = 125 \text{ A}$$

Por lo tanto, considerando solamente el régimen de carga constante, debería ser utilizado para cada fase un fusible WEG tam. 00 de **125 A**, que presenta  $I^2t$  de 6.350 A<sup>2</sup>s en 690 V y factor derating de  $1 \times I_n$  y  $0,85 \times I_n$  cuando es montado en base individual y seccionadora respectivamente. No obstante, como hay sobrecargas cíclicas de 300 A durante el arranque de la carga, este fusible actuaría indebidamente.

#### 3.3 - Análisis de la Sobrecarga Cíclica

Para evitar que el fusible aR WEG actúe indebidamente durante la corriente cíclica de arranque de esta carga, el fusible dimensionado deberá seguir la Tabla 1.

Después, si es utilizado un fusible WEG aR tamaño 00, su corriente de fusión en 30s deberá ser al menos 600 A ( $300 \times 2$ ). Para los fusibles WEG aR tamaños 1, 2 y 3, la corriente de fusión del fusible en 30 s deberá ser al menos 750 A ( $300 \times 2,5$ ). Por medio de las curvas tiempo x corriente del fusible aR WEG presentadas en el catálogo "Fusibles aR y gL/gG", se observa que podrá ser utilizado para esta aplicación el fusible FNH00 250 A aR WEG (que actúa en 30 segundos con aproximadamente 700 A).

#### 3.4 - $I^2t$ del Fusible

Este fusible posee  $I^2t$  de 43.980 en 690 V. Como se trata de alimentación de potencia conectada en estrella Y, la tensión sobre el fusible es la tensión de fase, y no la tensión de línea de 690 V. Donde:

$$V_F = \frac{V_L}{\sqrt{3}} = \frac{690}{\sqrt{3}} = 398,3 \text{ V}$$

Por medio del gráfico "Variación de  $I^2t$  total x tensión de trabajo" del catálogo "Fusibles aR y gL/gG", se observa que el valor de  $I^2t$  del 0FNH00 250 A aR WEG es reducido para 58% del valor en 690 V, resultando en 25.509 A<sup>2</sup>s ( $0,58 \times 43.980$ ).

Fusible especificado = FNH00-250K-A

Para uso en llave fusible SFW160-3 tenemos que verificar la capacidad máxima de la interruptor con este fusible (ver factor de reducción en el catálogo). O sea, la corriente de la carga no debe sobrepasar la corriente obtenida del conjunto fusible + llave.

En este caso, el factor de reducción = 0,6.

La corriente máxima permitida en régimen continuo es de  $250 \times 0,6 = 150$  A. Como el valor - 150 A es superior a la corriente de la carga - en este caso 125 A, no hay impedimento para el uso de **SFW160-3+ FNH00-250K-A**.



## Anexo 2: Tablas de Dimensionamiento de Fusibles aR para Protección de Arrancadores Suaves SSW y Convertidores CFW

Criterios utilizados para el dimensionamiento de los fusibles aR de las tablas de abajo:

- Tensión considerada para dimensionamiento del I<sup>2</sup>t:
  - Mayor tensión de línea del drive SSW o CFW.

Por ejemplo: SSW06 de 220 a 690 V ca =  $690/\sqrt{3} = 398$  V ca (tensión de fase aplicada en el fusible).

- Corriente del fusible:
  - Ver consideraciones anexo 1.
- I<sup>2</sup>t máximo del fusible = 0,75 x I<sup>2</sup>t indicado en el manual del drive CFW o SSW.

Nota: rev. 19

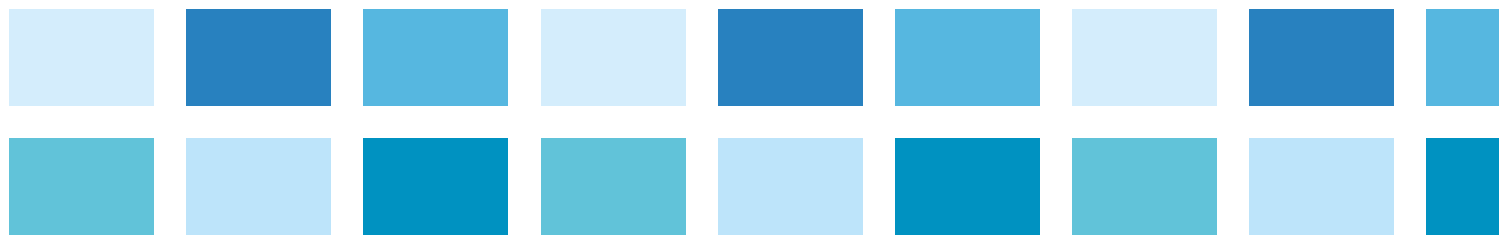





### Fusibles aR WEG Recomendados para el Arrancador Suave WEG Modelo SSW05 Plus

Modelo	Máximo I <sup>2</sup> t del fusible	Fusible(s) WEG FNH aR contacto cuchilla recomendado(s)					Fusible(s) WEG FNHFE aR flush end recomendado(s)				
		Tamaño	In (A)	Cantidad en paralelo	Item SAP	Referencia WEG	Tamaño	In (A)	Cantidad en paralelo	Item SAP	Referencia WEG
SSW05 Plus (A)	576	00	20	1	10687494	FNH00-20K-A	-	-	-	-	-
		000			13735555	FNH00-20K-A					
		00	35		10701721	FNH00-35K-A					
		000			13737105	FNH00-35K-A					
		00	40		10702117	FNH00-40K-A					
		000			13737107	FNH00-40K-A					
	00	63	10705764		FNH00-63K-A						
	000		13737129		FNH00-63K-A						
	00	80	10705995		FNH00-80K-A						
	000		13737130		FNH00-80K-A						
	00	125	10707231		FNH00-125K-A						
	000		13737132		FNH00-125K-A						
	00	160	10701724		FNH00-160K-A						
	00	200	10710732		FNH00-200K-A						

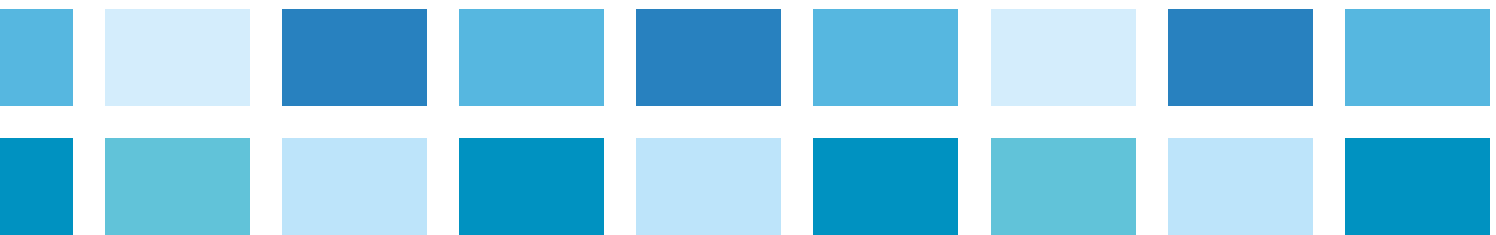

## Fusibles aR WEG Recomendados para el Arrancador Suave WEG Modelo SSW06

Modelo	I <sup>2</sup> t del SCR	I <sup>2</sup> t máximo del fusible (0,75% del SCR)	Fusible(s) aR WEG recomendado(s) para conexión estándar									
			FNH aR contacto cuchilla					FNHFE aR flush end				
SSW06 Plus (A)	(kA <sup>2</sup> s)	(kA <sup>2</sup> s)	Tamaño	In (A)	Cantidad en paralelo	Item SAP	Referencia WEG	Tamaño	In (A)	Cantidad en paralelo	Item SAP	Referencia WEG
10	0,72	0,54	00	40	1	10702117	FNH00-40K-A	-	-	-	-	-
16			000	35		13737105	FNH000-35K-A					
			00	40		10702117	FNH00-40K-A					
23			4	3,0		00	80					
	000	125				13737130	FNH000-80K-A					
30	00	100				10707231	FNH00-125K-A					
	000	100				13737131	FNH000-100K-A					
45	10	7,5	00	125		10707231	FNH00-125K-A					
60	15	11,25	00	160		10701724	FNH00-160K-A					
130	84	63	1	400		10815073	FNH1-400K-A					
205	320	240	2	630		10824110	FNH2-630K-A					
312	320	240	3	710		10833591	FNH3-710K-A					
412	1.452	1.089	3	1.000	11393565	FNH3-1000K-A						
							480	4.250	3.188	2	630	10824110
604	800	710	2	710	11393547	FNH2-710K-A						
							670	800	900	2	800	10833726
820	900	1.000	2	900	11393564	FNH3-900K-A						
							950	14.000	10.500	2	1.000	11393565
1,100	2	710	3	710	11393547	FNH2-710K-A						
							1,400	15.125	11.344	3	900	11393564

Notas: ■ Para esta aplicación, los fusibles no pueden ser montados en seccionadoras FSW y RFW, solamente en bases de fijación individual BNH.  
■ Se recomienda montar en bases de fijación individual BNH cuando sea aplicado más de un fusible por fase.  
■ Se pueden utilizar fusibles flush end tamaño 3, conectados en paralelo, de misma corriente nominal, tal que la suma de sus corrientes nominales sea igual a la corriente nominal especificada para el fusible flush end tamaño 23.

## Fusibles aR WEG Recomendados para el Arrancador Suave WEG Modelo SSW07

Modelo	Máximo I <sup>2</sup> t del fusible	Fusible(s) WEG FNH aR contacto cuchilla recomendado(s)					Fusible(s) WEG FNHFE aR flush end recomendado(s)				
SSW07 (A)	(A <sup>2</sup> s)	Tamaño	In (A)	Cantidad en paralelo	Item SAP	Referencia WEG	Tamaño	In (A)	Cantidad en paralelo	Item SAP	Referencia WEG
17	570	00	40	1	10702117	FNH00-40K-A	-	-	-	-	-
24		000			80	13737107					
	30	3.200	00		100	10705995					
000			80		13737130	FNH000-80K-A					
45	6.400	00	125		10707110	FNH00-100K-A					
		000	125		13737130	FNH000-80K-A					
61	8.400	00	160		10707231	FNH00-125K-A					
		000	160		13737132	FNH000-125K-A					
85	40.900	00	250		10701724	FNH00-160K-A					
		00	250		10711445	FNH00-250K-A					
130	77.600	1	400		10815073	FNH1-400K-A					
171	134.000	2	500		10824109	FNH2-500K-A					
200	196.000		630		10824110	FNH2-630K-A					
255	72.500	3	500		10833056	FNH3-500K-A					
312	190.000		710		500	10833591					
365		630									
412	256.000	3	500	2	10833056	FNH3-500K-A	700	12660657	FNH3FEM-700Y-A		

Nota: ■ Se recomienda montar en bases de fijación individual BNH cuando sea aplicado más de un fusible por fase.

Fusible(s) aR WEG recomendado(s) dentro de la conexión delta del motor										
FNH aR contacto cuchilla					FNHFE aR flush end					
Tamaño	In (A)	Cantidad en paralelo	Item SAP	Referencia WEG	Tamaño	In (A)	Cantidad en paralelo	Item SAP	Referencia WEG	
Conexión no aplicable					Conexión no aplicable					
1	200	1	10809133	FNH1-200K-A	-	-	-	-	-	
2	400		10824053	FNH2-400K-A	-	-	-	-	-	
3	500		10833056	FNH3-500K-A	3	550	1	12660187	FNH3FEM-550Y-A	
	710	10833591	FNH3-710K-A	630				12660583	FNH3FEM-630Y-A	
3	400	2	10831217	FNH3-400K-A	3	900	1	12660657	FNH3FEM-700Y-A	
2	315	3	10823936	FNH2-315K-A				1.000	12661662	FNH3FEM-900Y-A
3	500	2	10833056	FNH3-500K-A				1.100	12661663	FNH3FEM-1000Y-A
	710		10833591	FNH3-710K-A	1.250	12661664	FNH3FEM-1100Y-A			
	1.000	3	11393565	FNH3-1000K-A	1.600	12661665	FNH3FEM-1250Y-A			
800	3	10833726	FNH3-800K-A	23	1.800	1	12661689	FNH23FEA-1600Y-A		
3	800	3	10833726	FNH3-800K-A	3	1.100	2	12661664	FNH3FEM-1100Y-A	
	900		11393564	FNH3-900K-A				1.250	12661665	FNH3FEM-1250Y-A
	1.000	4	11393565	FNH3-1000K-A				1.400	12661666	FNH3FEM-1400Y-A
					1.250	3	12661665	FNH3FEM-1250Y-A		

### Fusibles aR WEG Recomendados para el Arrancador Suave WEG Modelo SSW08

Modelo	Máximo I <sup>2</sup> t del fusible (A²s)	Fusible(s) WEG FNH aR contacto cuchilla recomendado(s)					Fusible(s) WEG FNH aR contacto cuchilla recomendado(s)									
		Tamaño	In (A)	Cantidad en paralelo	Item SAP	Referencia WEG	Tamaño	In (A)	Cantidad en paralelo	Item SAP	Referencia WEG					
SSW08 (A)	720	00	40	1	10702117	FNH00-40K-A	-	-	-	-	-					
		000			13737107	FNH000-40K-A										
24	4.000	00	80		10705995	FNH00-80K-A										
		000			13737130	FNH000-80K-A										
30		00	100		10707110	FNH00-100K-A										
		000			13737131	FNH000-100K-A										
45	8.000	00	160		10701724	FNH00-160K-A										
61	10.500	1	200		10809133	FNH1-200K-A										
85	51.200	00	250		10711445	FNH00-250K-A										
130	97.000	2	400		10824053	FNH2-400K-A						3	450	1	12644962	FNH3FEM-450Y-A
171	169.000		500		10824109	FNH2-500K-A									12645317	FNH3FEM-500Y-A
200	245.000		630		10824110	FNH2-630K-A									12660187	FNH3FEM-550Y-A
255	89.000	3	500		10833056	FNH3-500K-A						550	12660583	FNH3FEM-630Y-A		
312	190.000		710		10833591	FNH3-710K-A						630	12660657	FNH3FEM-700Y-A		
365					500	10833056						FNH3-500K-A	700			
412	256.000	3	500		2											

Nota:   Se recomienda montar en bases de fijación individual BNH cuando sea aplicado más de un fusible por fase.

### Fusibles aR WEG Recomendados para el Arrancador Suave WEG Modelo SSW900 - Conexión Delta del Motor

Modelo	I <sup>2</sup> t del SCR	Fusible(s) aR WEG recomendado(s) para la conexión delta del motor																			
		El fusible queda FUERA del delta																			
		FNH aR contacto cuchilla					FNHFE aR flush end														
SSW900 (A)	(A <sup>2</sup> s)	Tamaño	In (A)	Cantidad en paralelo	Item SAP	Referencia WEG	Tamaño	In (A)	Cantidad en paralelo	Item SAP	Referencia WEG										
10	720	Conexión no aplicable					Conexión no aplicable														
17																					
24	4.000																				
30																					
45	8.000																				
61	10.500																				
85	51.200																				
105	125.000																				
130	97.000											3	500	1	10833056	FNH3-500K-A	3	450	1	12644962	FNH3FEM-450Y-A
171	168.000											2	710		11393547	FNH2-710K-A		550		12660187	FNH3FEM-550Y-A
200	245.000	3	800	10833726	FNH3-800K-A	630	12660583	FNH3FEM-630Y-A													
255	90.000	2	1.000	2	11393565	FNH3-1000K-A	800	12661660	FNH3FEM-800Y-A												
312	238.000		710		11393547	FNH2-710K-A	900	12661662	FNH3FEM-900Y-A												
365	320.000	3	800	2	10833726	FNH3-800K-A	1.100	12661664	FNH3FEM-1100Y-A												
412			900		11393564	FNH3-900K-A	1.250	12661665	FNH3FEM-1250Y-A												

Nota:  Se recomienda montar en bases de fijación individual BNH cuando sea aplicado más de un fusible por fase.

### Fusibles aR WEG Recomendados para el Arrancador Suave WEG Modelo SSW900 - Conexión Estándar

Fusible(s) aR WEG recomendado(s) para conexión estándar																
Modelo	I <sup>2</sup> t del SCR	FNH aR contacto cuchilla					FNHFE aR flush end									
SSW900 (A)	(A <sup>2</sup> s)	Tamaño	In (A)	Cantidad en paralelo	Item SAP	Referencia WEG	Tamaño	In (A)	Cantidad en paralelo	Item SAP	Referencia WEG					
10	720	00	40	1	10702117	FNH00-40K-A	-	-	-	-	-					
		000	35		13737105	FNH000-35K-A										
17		00	40		10702117	FNH00-40K-A										
		000	40		13737107	FNH000-40K-A										
24	4.000	00	80		10705995	FNH00-80K-A										
		000	80		13737130	FNH000-80K-A										
30		00	100		10707110	FNH00-100K-A										
		000	100		13737131	FNH000-100K-A										
45	8.000	00	125		10707231	FNH00-125K-A										
		000	125		13737132	FNH000-125K-A										
61		10.500	00		160	10701724						FNH00-160K-A				
85		51.200			250	10711445						FNH00-250K-A				
105	125.000	1	315		10809575	FNH1-315K-A						3	450	1	12644962	FNH3FEM-450Y-A
130	97.000		400		10815073	FNH1-400K-A										
171	168.000	2	500		10824109	FNH2-500K-A										
200	245.000		630		10824110	FNH2-630K-A										
255	90.000	3	500	10833056	FNH3-500K-A	500	12645317	FNH3FEM-500Y-A								
312	238.000		800	10833726	FNH3-800K-A	550	12660187	FNH3FEM-550Y-A								
365			900	11393564	FNH3-900K-A	630	12660583	FNH3FEM-630Y-A								
412			320.000	900	11393564	FNH3-900K-A	700	12660657	FNH3FEM-700Y-A							

Fusible(s) aR WEG recomendado(s) para la conexión delta del motor										
El fusible queda DENTRO del delta										
FNH aR contacto cuchilla					FNHFE aR flush end					
Tamaño	In (A)	Cantidad en paralelo	Item SAP	Referencia WEG	Tamaño	In (A)	Cantidad en paralelo	Item SAP	Referencia WEG	
Conexión no aplicable					Conexión no aplicable					
1	400	1	10815073	FNH1-400K-A	3	450	1	12644962	FNH3FEM-450Y-A	
2	500		10824109	FNH2-500K-A						
	630		10824110	FNH2-630K-A						
3	500		10833056	FNH3-500K-A						
	800		10833726	FNH3-800K-A						
	900	11393564	FNH3-900K-A							

### Fusibles aR WEG Recomendados para el Convertidor WEG Modelo CFW08

CFW08			Fusible(s) WEG FNH aR contacto cuchilla recomendado(s)				
Modelo	Tensión (V ca)	I <sup>t</sup> máximo del fusible en 25 °C (A <sup>2</sup> s)	Tamaño	In (A)	Cantidad en paralelo	Item SAP	Referencia WEG
CFW080016S2024	200-240 monofásico	125	00	20	1	10687494	FNH00-20K-A
CFW080026S2024			000			13735555	FNH000-20K-A
			00			10687494	FNH00-20K-A
CFW080040S2024			000			13735555	FNH000-20K-A
			00			10687494	FNH00-20K-A
CFW080016B2024			000			13735555	FNH000-20K-A
	00	10687494	FNH00-20K-A				
CFW080026B2024	000	13735555	FNH000-20K-A				
	00	10687494	FNH00-20K-A				
CFW080040B2024	000	13735555	FNH000-20K-A				
	00	10687494	FNH00-20K-A				
CFW080073B2024	200-240 monofásico y trifásico	260	00	35		10701721	FNH00-35K-A
			000			13737105	FNH000-35K-A
00			10701721			FNH00-35K-A	
000			13737105			FNH000-35K-A	
CFW080070T2024			00			10687494	FNH00-20K-A
			000			13735555	FNH000-20K-A
CFW080160T2024	200-240 trifásico	260	00	40		10702117	FNH00-40K-A
			000	35	13737105	FNH000-35K-A	
00			25	10701722	FNH00-25K-A		
000			40	13737107	FNH000-40K-A		
CFW080017T2024POH3Z			00	40	10702117	FNH00-40K-A	
			000	13737107	FNH000-40K-A		
CFW080220T2024	340	800	1	63	10806688	FNH1-63K-A	
CFW080280T2024			1	100	10807553	FNH1-100K-A	
CFW080330T2024							

### Fusibles aR WEG Recomendados para el Convertidor WEG Modelo CFW08

CFW08			Fusible(s) WEG FNH aR contacto cuchilla recomendado(s)				
Modelo	Tensión (V ca)	I <sup>t</sup> máximo del fusible en 25 °C (A <sup>2</sup> s)	Tamaño	In (A)	Cantidad en paralelo	Item SAP	Referencia WEG
CFW080010T3848 CFW080016T3848 CFW080026T3848 CFW080040T3848 CFW080027T3848 CFW080043T3848 CFW080065T3848 CFW0800100T3848 CFW080130T3848 CFW080160T3848 CFW080240T3848 CFW080300T3848	380-480 trifásico	125	00	20	1	10687494	FNH00-20K-A
			000			13735555	FNH000-20K-A
			00			10687494	FNH00-20K-A
			000			13735555	FNH000-20K-A
			00			10687494	FNH00-20K-A
			000			13735555	FNH000-20K-A
		260	00	10687494		FNH00-20K-A	
			000	13735555		FNH000-20K-A	
			00	10687494		FNH00-20K-A	
			000	13735555		FNH000-20K-A	
			00	10687494		FNH00-20K-A	
			000	13735555		FNH000-20K-A	
		340	00	25		10701722	FNH00-25K-A
			000	13735656		FNH000-25K-A	
			00	35		10701721	FNH00-35K-A
			000	13737105		FNH000-35K-A	
			00	40		10702117	FNH00-40K-A
			000	13737107		FNH000-40K-A	
800	00	50	10701718	FNH00-50K-A			
	000	13737128	FNH000-50K-A				
00	80	10807549	FNH1-80K-A				
CFW080017T5060 CFW080030T5060 CFW080043T5060 CFW080070T5060 CFW080100T5060 CFW080120T5060	575 trifásico	340	00	20	10687494	FNH00-20K-A	
			000		13735555	FNH000-20K-A	
			00		10687494	FNH00-20K-A	
			000		13735555	FNH000-20K-A	
			00		10687494	FNH00-20K-A	
			000		13735555	FNH000-20K-A	
		25	00	10701722	FNH00-25K-A		
			000	13735656	FNH000-25K-A		
		35	00	10701721	FNH00-35K-A		
			000	13737105	FNH000-35K-A		

### Fusibles aR WEG Recomendados para el Convertidor WEG Modelo CFW09

Corriente nominal del convertidor CFW09 A/V		Máximo I <sup>t</sup> del fusible	Fusible(s) WEG FNH aR contacto cuchilla recomendado(s)					Fusible(s) WEG FNHFE aR flush end recomendado(s)				
CT	VT	(A <sup>2</sup> s)	Tamaño	In (A)	Cantidad en paralelo	Item SAP	Referencia WEG	Tamaño	In (A)	Cantidad en paralelo	Item SAP	Referencia WEG
2,9/500-600	4,2/500-600	450	00	20	1	10687494	FNH00-20K-A					
			000			13735555	FNH000-20K-A					
3,6/380-480	-	450	00	20	1	10687494	FNH00-20K-A					
			000			13735555	FNH000-20K-A					
4,0/380-480	-	450	00	20	1	10687494	FNH00-20K-A					
			000			13735555	FNH000-20K-A					
4,2/500-600	7,0/500-600	450	00	25	1	10687494	FNH00-20K-A					
			000			13735555	FNH000-20K-A					
5,5/380-480	-	450	00	20	1	10701722	FNH00-25K-A					
			000			13735555	FNH000-20K-A					
6,0/220-230	-	450	00	25	1	10701722	FNH00-25K-A					
			000			13735555	FNH000-20K-A					
7,0/220-230	-	450	00	25	1	10701722	FNH00-25K-A					
			000			13735555	FNH000-20K-A					
7,0/500-600	10/500-600	450	00	25	1	10701722	FNH00-25K-A					
			000			13735656	FNH000-25K-A					
9,0/380-480	-	450	00	35	1	10701722	FNH00-25K-A					
			000			13735656	FNH000-25K-A					
10/220-230	-	450	00	35	1	10701721	FNH00-35K-A					
			000			13735656	FNH000-25K-A					
10/500-600	12/500-600	450	00	25	1	10701722	FNH00-25K-A					
			000			13735656	FNH000-25K-A					
12/500-600	14/500-600	500	00	35	1	10701721	FNH00-35K-A					
			000			13737105	FNH000-35K-A					
13/220-230	-	500	00	35	1	10701721	FNH00-35K-A					
			000			13737105	FNH000-35K-A					
13/380-480	-	500	00	35	1	10701721	FNH00-35K-A					
			000			13737105	FNH000-35K-A					
14/500-600	-	500	00	35	1	10701721	FNH00-35K-A					
			000			13737105	FNH000-35K-A					
16/220-230	-	500	00	40	1	10701721	FNH00-35K-A					
			000			13737107	FNH000-40K-A					

### Fusibles aR WEG Recomendados para el Convertidor WEG Modelo CFW09

Corriente nominal del convertidor CFW09 AV		Máximo I <sub>p</sub> t del fusible	Fusible(s) WEG FNH aR contacto cuchilla recomendado(s)					Fusible(s) WEG FNHFE aR flush end recomendado(s)					
CT	VT	(A's)	Tamaño	In (A)	Cantidad en paralelo	Item SAP	Referencia WEG	Tamaño	In (A)	Cantidad en paralelo	Item SAP	Referencia WEG	
22/500-600	27/500-600	7.200	00	50	1	10701718	FNH00-50K-A	-	-	-	-	-	
			000			13737128	FNH000-50K-A						
24/220-230	-	500	00	40		10702117	FNH00-40K-A						
			000			13737107	FNH000-40K-A						
24/380-480	-	1.250	00	50		10701718	FNH00-50K-A						
			000			13737128	FNH000-50K-A						
27/500-600	32/500-600	7.200	00	63		10705764	FNH00-63K-A						
			000				13737129						FNH000-63K-A
28/220-230	-	1.250	00				10705764						FNH00-63K-A
			000				13737129						FNH000-63K-A
30/380-480	36/380-480	2.100	00			10705764	FNH00-63K-A						
			000			13737129	FNH000-63K-A						
32/500-600	-	7.200	00			10705764	FNH00-63K-A						
			000			13737129	FNH000-63K-A						
38/380-480	45/380-480	7.200	00		80	10705995	FNH00-80K-A						
			000		100	13737131	FNH000-100K-A						
44/500-600	53/500-600	14.400	00	80	10705995	FNH00-80K-A							
			000	100	13737131	FNH000-100K-A							
45/220-230	-	2.450	00	80	10705995	FNH00-80K-A							
			000	100	13737131	FNH000-100K-A							
45/380-480	54/380-480	7.200	00	80	10705995	FNH00-80K-A							
			000	100	13737131	FNH000-100K-A							
53/500-600	63/500-600	14.400	00	100	10707110	FNH00-100K-A							
			000	125	13737132	FNH000-125K-A							
54/220-230	68/220-230	7.200	00	100	10707110	FNH00-100K-A							
60/380-480	70/380-480	14.400		125	10707231	FNH00-125K-A							
63/500-600	79/500-600			125	10707231	FNH00-125K-A							
70/220-230	86/220-230			160	10707231	FNH00-125K-A							
70/380-480	86/380-480			160	10701724	FNH00-160K-A							
79/500-600	99/500-600	21.600		1	160	10701724	FNH00-160K-A						
86/220-230	105/220-230	14.400			200	10710732	FNH00-200K-A						
86/380-480	105/380-480	21.600			250	10710732	FNH00-200K-A						
100/660-690	127/660-690	320.000			315	10711445	FNH00-250K-A						
105/220-230	130/220-230	21.600			350	10809575	FNH1-315K-A						
105/380-480	130/380-480		10809575			FNH1-315K-A							
107/500-690	147/500-690	320.000	2		350	10814896	FNH1-350K-A						
127/660-690	179/660-690	21.600			400	10814896	FNH1-350K-A						
130/220-230	150/220-230					450	10815073	FNH1-400K-A					
142/380-480	174/380-480	320.000			500	10815073	FNH1-400K-A						
147/500-690	196/500-690			500		10824055	FNH2-450K-A						
179/660-690	179/660-690	320.000		3	500	10824055	FNH2-450K-A						
180/380-480	-	320.000			630	10824109	FNH2-500K-A						
211/380-480	-					630	10824110	FNH2-630K-A					
211/500-690	259/660-690	414.000			710	10824110	FNH2-630K-A						
225/660-690	-					710	11393547	FNH2-710K-A					
240/380-480	-	414.000	800		10824110	FNH2-630K-A							
247/500-690	315/500-690				800	10833726	FNH3-800K-A						
259/660-690	305/660-690	1.051.000	900		10833591	FNH3-710K-A							
305/660-690	340/660-690				900	10833591	FNH3-710K-A						
312/380-480	-	1.051.000	1.000		11393564	FNH3-900K-A							
315/500-690	343/500-690			1.000	11393564	FNH3-900K-A							
340/660-690	428/660-690	1.445.000	900	11393565	FNH3-1000K-A								
343/500-690	418/500-690			900	11393564	FNH3-900K-A							
361/380-480	-	1.445.000	1.000	11393565	FNH3-1000K-A								
418/500-690	472/500-690			1.000	11393565	FNH3-1000K-A							
428/660-690	428/660-690	1.051.000	630	10824110	FNH2-630K-A								
472/500-690	555/500-690			630	10824110	FNH2-630K-A							
450/380-480	-	1.051.000	900	11393564	FNH3-900K-A								
515/380-480	-			900	11393565	FNH3-1000K-A							
600/380-480	-	1.445.000	2	630	2	10824110	FNH2-630K-A	900	12661662	FNH3FEM-900Y-A			

Nota:  Se recomienda montar en bases de fijación individual BNH cuando sea aplicado más de un fusible por fase.

### Fusibles aR WEG Recomendados para el Convertidor WEG Modelo CFW11

CFW11				Máximo I <sup>2</sup> t del fusible						
Modelo	Mecánica	IGBT de frenado	Tensión de alimentación (V ca)	(A <sup>2</sup> s)						
CFW110010S2SZ	A	Incorporado (interno)	220	Monofásica	1.000					
CFW110006B2SZ				Monofásica o trifásica	420					
CFW110007B2SZ										
CFW110007T2SZ										
CFW110010T2SZ										
CFW110013T2SZ										
CFW110016T2SZ										
CFW110024T2SZ	B			Incorporado (interno)		220	1.000			
CFW110028T2SZ										
CFW110033T2SZ										
CFW110045T2SZ	C				Incorporado (interno)		220	2.750		
CFW110054T2SZ										
CFW110070T2SZ										
CFW110086T2SZ	D							Incorporado (interno)	220	3.150
CFW110105T2SZ										
CFW110142T2SZ	E	No incorporado	220							39.200
CFW110180T2SZ		Incorporado (interno)								218.000
CFW110211T2SZ										39.200
CFW110142T20DBZ		218.000								
CFW110180T20DBZ										
CFW110211T20DBZ										
CFW110003T4SZ		A		Incorporado (interno)		380				190
CFW110005T4SZ										
CFW110007T4SZ										
CFW110010T4SZ										
CFW110013T4SZ	495									
CFW110017T4SZ		500								
CFW110024T4SZ										
CFW110031T4SZ	1.250									
CFW110038T4SZ		2.100								
CFW110045T4SZ			2.100							
CFW110058T4SZ										
CFW110070T4SZ	D	Incorporado (interno)			380		3.150			
CFW110088T4SZ										

Notas: ■ Para esta aplicación, los fusibles no pueden ser montados en seccionadoras FSW o RFW, solamente en bases de fijación individual BNH.  
■ Se recomienda montar en bases de fijación individual BNH cuando sea aplicado más de un fusible por fase.



Fusible(s) WEG FNH aR contacto cuchilla recomendado(s)						Fusible(s) WEG FNHFE aR flush end recomendado(s)				
Tamaño	In (A)	Cantidad en paralelo	Item SAP	Referencia WEG	Tamaño	In (A)	Cantidad en paralelo	Item SAP	Referencia WEG	
00	20	1	10687494	FNH00-20K-A						
000			13735555	FNH000-20K-A						
00			10687494	FNH00-20K-A						
000			13735555	FNH000-20K-A						
00			10687494	FNH00-20K-A						
000			13735555	FNH000-20K-A						
00			10687494	FNH00-20K-A						
000			13735555	FNH000-20K-A						
00			10687494	FNH00-20K-A						
000			13735555	FNH000-20K-A						
00			10701722	FNH00-25K-A						
000			13735656	FNH000-25K-A						
00			10701721	FNH00-35K-A						
000			13737105	FNH000-35K-A						
00	10702117	FNH00-40K-A								
000	13737107	FNH000-40K-A								
00	10701718	FNH00-50K-A								
000	13737128	FNH000-50K-A								
00	10705764	FNH00-63K-A								
000	13737129	FNH000-63K-A								
00	10705995	FNH00-80K-A								
000	13737130	FNH000-80K-A								
00	10705995	FNH00-80K-A								
000	13737131	FNH000-100K-A								
00	10707110	FNH00-100K-A								
000	100	1	13737131	FNH000-100K-A						
00	125	1	10707231	FNH00-125K-A						
	250		10711445	FNH00-250K-A						
1	350		10814896	FNH1-350K-A						
	400		10815073	FNH1-400K-A						
00	250		10711445	FNH00-250K-A						
1	350		10814896	FNH1-350K-A						
	400		10815073	FNH1-400K-A						
00	20		10687494	FNH00-20K-A						
000			13735555	FNH000-20K-A						
00			10687494	FNH00-20K-A						
000			13735555	FNH000-20K-A						
00			10687494	FNH00-20K-A						
000			13735555	FNH000-20K-A						
00			10687494	FNH00-20K-A						
000		13735555	FNH000-20K-A							
00		10701722	FNH00-25K-A							
000		13735656	FNH000-25K-A							
00		10701721	FNH00-35K-A							
000		13737105	FNH000-35K-A							
00		10702117	FNH00-40K-A							
000		13737107	FNH000-40K-A							
00	10701718	FNH00-50K-A								
000	13737128	FNH000-50K-A								
00	10705764	FNH00-63K-A								
000	13737129	FNH000-63K-A								
00	10705995	FNH00-80K-A								
000	13737130	FNH000-80K-A								
00	10707110	FNH00-100K-A								
000	80	13737130	FNH000-80K-A							
	100	10707110	FNH00-100K-A							
00	125	10707231	FNH00-125K-A							

### Fusibles aR WEG Recomendados para el Convertidor WEG Modelo CFW11

Modelo	CFW11			Máximo I <sup>2</sup> t del fusible		
	Mecánica	IGBT de frenado	Tensión de alimentación (V ca)	(A <sup>2</sup> s)		
CFW110105T4SZ	E	No incorporado	380	39.200		
CFW110142T4SZ				Incorporado (interno)	218.000	
CFW110180T4SZ					39.200	
CFW110211T4SZ					218.000	
CFW110105T40DBZ		Accesorio externo (usar DBW03)			320.000	
CFW110142T40DBZ				414.000		
CFW110180T40DBZ				1.051.000		
CFW110211T40DBZ				1.445.000		
CFW110242T4SZ	F	Accesorio externo (usar DBW04)		1.051.000		
CFW110312T4SZ				1.445.000		
CFW110370T4SZ				1.051.000		
CFW110477T4SZ				1.445.000		
CFW110515T4SZ	G			440	190	
CFW110601T4SZ					Incorporado (interno)	495
CFW110720T4SZ						500
CFW110795T4SZ						1.250
CFW110877T4SZ	2.100					
CFW111062T4SZ	3.150					
CFW111141T4SZ	39.200					
CFW110003T4SZ	A	Trifásica	218.000			
CFW110005T4SZ			Incorporado (interno)			218.000
CFW110007T4SZ					39.200	
CFW110010T4SZ					218.000	
CFW110013T4SZ	Accesorio externo (usar DBW03)				320.000	
CFW110017T4SZ			414.000			
CFW110024T4SZ			1.051.000			
CFW110031T4SZ			1.445.000			
CFW110038T4SZ	C		440		190	
CFW110045T4SZ				Incorporado (interno)	495	
CFW110058T4SZ					500	
CFW110070T4SZ					1.250	
CFW110088T4SZ	2.100					
CFW110105T4SZ	3.150					
CFW110142T4SZ	E			Trifásica	39.200	
CFW110180T4SZ					Incorporado (interno)	218.000
CFW110211T4SZ		39.200				
CFW110105T40DBZ		218.000				
CFW110142T40DBZ	Accesorio externo (usar DBW03)	320.000				
CFW110180T40DBZ		414.000				
CFW110211T40DBZ		1.051.000				
CFW110242T4SZ		1.445.000				
CFW110312T4SZ	F	440			190	
CFW110370T4SZ					Incorporado (interno)	495
CFW110477T4SZ			500			
CFW110515T4SZ			1.250			
CFW110601T4SZ	2.100					
CFW110720T4SZ	3.150					
CFW110760T4SZ	G		Trifásica		39.200	
					Incorporado (interno)	218.000
				39.200		
				218.000		
	Accesorio externo (usar DBW03)			320.000		
				414.000		
				1.051.000		
				1.445.000		

Notas:   Para esta aplicación, los fusibles no pueden ser montados en seccionadoras FSW o RFW, solamente en bases de fijación individual BNH.  
  Se recomienda montar en bases de fijación individual BNH cuando sea aplicado más de un fusible por fase.

Fusible(s) WEG FNH aR contacto cuchilla recomendado(s)						Fusible(s) WEG FNHFE aR flush end recomendado(s)				
Tamaño	In (A)	Cantidad en paralelo	Item SAP	Referencia WEG	Tamaño	In (A)	Cantidad en paralelo	Item SAP	Referencia WEG	
00	160	1	10701724	FNH00-160K-A	-	-	-	-	-	
	250		10711445	FNH00-250K-A						
1	350		10814896	FNH1-350K-A	3	450	1	12644962	FNH3FEM-450Y-A	
	400		10815073	FNH1-400K-A						
00	160		1	10701724	FNH00-160K-A	-	-	-	-	-
	250			10711445	FNH00-250K-A					
1	350			10814896	FNH1-350K-A	-	450	-	12644962	FNH3FEM-450Y-A
	400			10815073	FNH1-400K-A					
2	450			10824055	FNH2-450K-A	-	500	-	12645317	FNH3FEM-500Y-A
	630			10824110	FNH2-630K-A					
	710	11393547		FNH2-710K-A						
3	900	11393564		FNH3-900K-A	-	630	-	12660583	FNH3FEM-630Y-A	
	1.000	11393565		FNH3-1000K-A						
2	630	2		10824110	FNH2-630K-A	3	700	1	12660657	FNH3FEM-700Y-A
	710		11393547	FNH2-710K-A						
3	800		10833726	FNH3-800K-A	-	800	-	12661660	FNH3FEM-800Y-A	
	900		11393564	FNH3-900K-A						
3	900		2	11393564	FNH3-900K-A	-	1.250	-	12661665	FNH3FEM-1250Y-A
	900									
00	20			10687494	FNH00-20K-A	-	-	-	-	-
000				13735555	FNH000-20K-A					
00				10687494	FNH00-20K-A					
000				13735555	FNH000-20K-A					
00		10687494		FNH00-20K-A						
000		13735555		FNH000-20K-A						
00		10687494		FNH00-20K-A						
000		13735555		FNH000-20K-A						
00		25	10701722	FNH00-25K-A						
000			13735656	FNH000-25K-A						
00	35	10701721	FNH00-35K-A							
000		13737105	FNH000-35K-A							
00	40	10702117	FNH00-40K-A							
000		13737107	FNH000-40K-A							
00	50	10701718	FNH00-50K-A							
000		13737128	FNH000-50K-A							
00	80	10705995	FNH00-80K-A							
000	63	13737129	FNH000-63K-A							
00	80	10705995	FNH00-80K-A							
000	80	13737130	FNH000-80K-A							
00	100	10707110	FNH00-100K-A							
000	80	13737130	FNH000-80K-A							
00	100	10707110	FNH00-100K-A							
00	125	10707231	FNH00-125K-A							
00	160	10701724	FNH00-160K-A							
	250	10711445	FNH00-250K-A							
1	350	10814896	FNH1-350K-A	3	450	1	12644962	FNH3FEM-450Y-A		
	400	10815073	FNH1-400K-A							
00	160	10701724	FNH00-160K-A	-	-	-	-	-		
	250	10711445	FNH00-250K-A							
1	350	10814896	FNH1-350K-A	-	450	-	12644962	FNH3FEM-450Y-A		
	400	10815073	FNH1-400K-A							
2	450	10824055	FNH2-450K-A	-	500	-	12645317	FNH3FEM-500Y-A		
	630	10824110	FNH2-630K-A							
2	710	11393547	FNH2-710K-A	3	630	1	12660583	FNH3FEM-630Y-A		
	900	11393564	FNH3-900K-A							
3	900	11393565	FNH3-1000K-A	-	700	-	12660657	FNH3FEM-700Y-A		
	1.000	11393565	FNH3-1000K-A							
2	630	2	10824110	FNH2-630K-A	-	800	-	12661660	FNH3FEM-800Y-A	
	710		11393547	FNH2-710K-A						
2	710		11393547	FNH2-710K-A	-	900	-	12661662	FNH3FEM-900Y-A	
	710		11393547	FNH2-710K-A						

### Fusibles aR WEG Recomendados para el Convertidor WEG Modelo CFW11

Modelo	CFW11			Máximo I <sup>2</sup> t del fusible
	Mecánica	IGBT de frenado	Tensión de alimentación (V ca)	(A <sup>2</sup> s)
CFW110795T4SZ	H	Accesorio externo (usar DBW04)	440	1.051.000
CFW110877T4SZ				
CFW1101062T4SZ				
CFW1101141T4SZ				
CFW110002T50NFYZ	B	Incorporado (interno)	600	1.250
CFW110004T50NFYZ				
CFW110007T50NFYZ				
CFW110010T50NFYZ				
CFW110012T50NFYZ				
CFW110017T50NFYZ				
CFW110022T5	C	-	600	7.200
CFW110027T5				
CFW110032T5				
CFW110044T5				
CFW110022T50NFYZ	D	Incorporado (interno)	600	39.200
CFW110027T50NFYZ				
CFW110032T50NFYZ				
CFW110044T50NFYZ				
CFW110053T60YZ	E	No incorporado	600	218.000
CFW110063T60YZ				
CFW110080T60YZ				
CFW110107T60YZ				
CFW110125T60YZ				
CFW110150T60YZ		Incorporado (interno)	600	39.200
CFW110053T60YZ				
CFW110063T60DBYZ				
CFW110080T60DBYZ				
CFW110107T60DBYZ				
CFW110125T60DBYZ	F	Accesorio externo (usar DBW03)	600	320.000
CFW110150T60DBYZ				
CFW110170T60YZ				
CFW110216T60YZ				
CFW110289T60YZ	G	Accesorio externo (usar DBW03)	600	414.000
CFW110315T60YZ				
CFW110365T60YZ				
CFW110435T60YZ	H	Accesorio externo (usar DBW04)	600	1.051.000
CFW110584T60YZ				
CFW110625T60YZ				
CFW110758T60YZ				
CFW110804T60YZ				1.445.000
				1.620.000

Notas: ■ Para esta aplicación, los fusibles no pueden ser montados en seccionadoras FSW o RFW, solamente en bases de fijación individual BNH.  
■ Se recomienda montar en bases de fijación individual BNH cuando sea aplicado más de un fusible por fase.

Fusible(s) WEG FNH aR contacto cuchilla recomendado(s)					Fusible(s) WEG FNHFE aR flush end recomendado(s)					
Tamaño	In (A)	Cantidad en paralelo	Item SAP	Referencia WEG	Tamaño	In (A)	Cantidad en paralelo	Item SAP	Referencia WEG	
3	800	2	10833726	FNH3-800K-A	3	1.000	1	12661663	FNH3FEM-1000Y-A	
3	900	2	11393564	FNH3-900K-A		1.250		12661665	FNH3FEM-1250Y-A	
00						1.400		12661666	FNH3FEM-1400Y-A	
00	20	1	10687494	FNH00-20K-A	-	-	-	-	-	
000			13735555	FNH000-20K-A						
00			10687494	FNH00-20K-A						
000			13735555	FNH000-20K-A						
00			10687494	FNH00-20K-A						
000			13735555	FNH000-20K-A						
00			10687494	FNH00-20K-A						
000			13735555	FNH000-20K-A						
00			25	10701722						FNH00-25K-A
000				13735656						FNH000-25K-A
00			35	10701721						FNH00-35K-A
000				13737105						FNH000-35K-A
00			40	10702117						FNH00-40K-A
000				13737107						FNH000-40K-A
00			50	10701718						FNH00-50K-A
000				13737128						FNH000-50K-A
00			63	10705764						FNH00-63K-A
000				13737129						FNH000-63K-A
00			80	10705995						FNH00-80K-A
000				13737130						FNH000-80K-A
00	40	10702117	FNH00-40K-A							
000		13737107	FNH000-40K-A							
00	50	10701718	FNH00-50K-A							
000		13737128	FNH000-50K-A							
00	63	10705764	FNH00-63K-A							
000		13737129	FNH000-63K-A							
00	80	10705995	FNH00-80K-A							
000		13737130	FNH000-80K-A							
00	100	10705995	FNH00-80K-A							
000		13737131	FNH000-100K-A							
00	125	10707110	FNH00-100K-A							
000		13737132	FNH000-125K-A							
00	125	10707231	FNH00-125K-A							
000		13737132	FNH000-125K-A							
00	160		10701724	FNH00-160K-A	3	450	1	12644962	FNH3FEM-450Y-A	
00	200		10710732	FNH00-200K-A						
00	250		10711445	FNH00-250K-A						
00	80		10705995	FNH00-80K-A	-	-	-	-	-	
000	100	13737131	FNH000-100K-A							
00		10707110	FNH00-100K-A							
000	125	13737132	FNH000-125K-A							
00		10707231	FNH00-125K-A							
000	125		13737132	FNH000-125K-A	-	-	-	-	-	
00	160		10701724	FNH00-160K-A						
00	200		10710732	FNH00-200K-A						
00	250		10711445	FNH00-250K-A	3	450	1	12644962	FNH3FEM-450Y-A	
00	350		10814896	FNH1-350K-A						
00	400		10815073	FNH1-400K-A						
00	630		10824110	FNH2-630K-A	3	500	1	12645317	FNH3FEM-500Y-A	
00	710		11393547	FNH2-710K-A						
00	800		10833726	FNH3-800K-A						
00	800		10833726	FNH3-800K-A	3	630	1	12660583	FNH3FEM-630Y-A	
00	630		10824110	FNH2-630K-A						
00	710		11393547	FNH2-710K-A						
00	800		10833726	FNH3-800K-A	2	800	1	12661660	FNH3FEM-800Y-A	
00	630		10824110	FNH2-630K-A						
00	710		11393547	FNH2-710K-A						
00	800		10833726	FNH3-800K-A	2	900	1	12661662	FNH3FEM-900Y-A	
00	630		10824110	FNH2-630K-A						
00	710		11393547	FNH2-710K-A						
00	800		10833726	FNH3-800K-A	2	1,000	1	12661663	FNH3FEM-1000Y-A	
00	630		10824110	FNH2-630K-A						
00	710		11393547	FNH2-710K-A						
00	800		10833726	FNH3-800K-A	2	1,000	1	12661663	FNH3FEM-1000Y-A	
00	630		10824110	FNH2-630K-A						
00	710		11393547	FNH2-710K-A						

### Fusibles aR WEG Recomendados para el Convertidor WEG Modelo CFW11

CFW11				Máximo I <sup>2</sup> t del fusible	
Modelo	Mecánica	IGBT de frenado	Tensión de alimentación (V ca)	(A <sup>2</sup> s)	
CFW110022T50NFYZ	D	Incorporado (interno)	690	Trifásica	7.200
CFW110027T50NFYZ					
CFW110032T50NFYZ					
CFW110044T50NFYZ					
CFW110053T60YZ	E	No incorporado	690	Trifásica	39.200
CFW110063T60YZ					
CFW110080T60YZ					
CFW110107T60YZ					
CFW110125T60YZ					
CFW110150T60YZ					
CFW110053T60YZ		Incorporado (interno)			39.200
CFW110063T60DBYZ					
CFW110080T60DBYZ					
CFW110107T60DBYZ					
CFW110125T60DBYZ	F	Accesorio externo (usar DBW03)	690	Trifásica	218.000
CFW110150T60DBYZ					
CFW110170T60YZ					
CFW110216T60YZ					
CFW110289T60YZ					
CFW110315T60YZ					
CFW110365T60YZ	G	1.051.000	690	Trifásica	320.000
CFW110435T60YZ					
CFW110472T60YZ					
CFW110584T60YZ	H	Accesorio externo (usar DBW04)	690	Trifásica	414.000
CFW110625T60YZ					
CFW110758T60YZ					
CFW110804T60YZ					
CFW110804T60YZ					1.620.000

Notas:  Para esta aplicación, los fusibles no pueden ser montados en seccionadoras FSW o RFW, solamente en bases de fijación individual BNH.  
 Se recomienda montar en bases de fijación individual BNH cuando sea aplicado más de un fusible por fase.

### Fusibles aR WEG Recomendados para el Convertidor WEG Modelo CFW100

CFW100				Máximo I <sup>2</sup> t del fusible	
Modelo	Mecánica	IGBT de frenado	Tensión de alimentación (V ca)	(A <sup>2</sup> s)	
CFW100A01P6S220	A	No incorporado	220	Monofásica	166
CFW100B02P6S220					
CFW100C04P2S220					
					500

Fusible(s) WEG FNH aR contacto cuchilla recomendado(s)						Fusible(s) WEG FNHFE aR flush end recomendado(s)				
Tamaño	In (A)	Cantidad en paralelo	Item SAP	Referencia WEG	Tamaño	In (A)	Cantidad en paralelo	Item SAP	Referencia WEG	
00	40	1	10702117	FNH00-40K-A	-	-	-	-	-	
000			13737107	FNH000-40K-A						
00	50	1	10701718	FNH00-50K-A						
000			13737128	FNH000-50K-A						
00	63	1	10705764	FNH00-63K-A						
000			13737129	FNH000-63K-A						
00	80	1	10705995	FNH00-80K-A						
000			13737130	FNH000-80K-A						
00			10705995	FNH00-80K-A						
000	100	1	13737131	FNH000-100K-A						
00			10707110	FNH00-100K-A						
000	125	1	13737132	FNH000-125K-A						
00			10707231	FNH00-125K-A						
000	125	1	13737132	FNH000-125K-A						
00	160	1	10701724	FNH00-160K-A						
00	200		10710732	FNH00-200K-A						
00	250		10711445	FNH00-250K-A						
00	80		10705995	FNH00-80K-A						
000	100		13737131	FNH000-100K-A						
00			10707110	FNH00-100K-A						
000	125		13737132	FNH000-125K-A						
00			10707231	FNH00-125K-A						
000	125		1	13737132						FNH000-125K-A
00	160		10701724	FNH00-160K-A						
00	200		10710732	FNH00-200K-A						
00	250		10711445	FNH00-250K-A						
1	350		10814896	FNH1-350K-A						
1	400		10815073	FNH1-400K-A						
2	630		10824110	FNH2-630K-A						
	710		10824110	FNH2-630K-A						
3	800		11393547	FNH2-710K-A						
	900		10833726	FNH3-800K-A						
	1.000		11393564	FNH3-900K-A						
3	710		2	11393565	FNH3-1000K-A					
	800			10833591	FNH3-710K-A					
	800		10833726	FNH3-800K-A						
						3	450	1	12644962	FNH3FEM-450Y-A
						-	-	-	-	-
					3	450	1	12644962	FNH3FEM-450Y-A	
					3	500	1	12645317	FNH3FEM-500Y-A	
					3	630	1	12660583	FNH3FEM-630Y-A	
					3	700	1	12660657	FNH3FEM-700Y-A	
					3	800	1	12661660	FNH3FEM-800Y-A	
					3	900	1	12661662	FNH3FEM-900Y-A	

Fusible(s) WEG FNH aR contacto cuchilla recomendado(s)						Fusible(s) WEG FNHFE aR flush end recomendado(s)				
Tamaño	In (A)	Cantidad en paralelo	Item SAP	Referencia WEG	Tamaño	In (A)	Cantidad en paralelo	Item SAP	Referencia WEG	
00	20	1	10687494	FNH00-20K-A	-	-	-	-	-	
000			13735555	FNH000-20K-A						
00			10687494	FNH00-20K-A						
000			13735555	FNH000-20K-A						
00			10687494	FNH00-20K-A						
000			13735555	FNH000-20K-A						

### Fusibles aR WEG Recomendados para o Convertidor WEG Modelo CFW300

CFW300		Máximo Pt del fusible	Fusible(s) WEG FNH aR contacto cuchilla recomendado(s)					Fusible(s) WEG FNHFE aR flush end recomendado(s)				
Modelo	Tensión de alimentación (V ca)	(A <sup>2</sup> s)	Tamaño	In (A)	Cantidad en paralelo	Item SAP	Referencia WEG	Tamaño	In (A)	Cantidad en paralelo	Item SAP	Referencia WEG
CFW300A01P6S120	110...127 monofásica	166	00	20	1	10687494	FNH00-20K-A					
			000			13735555	FNH000-20K-A					
CFW300A02P6S120			00			10687494	FNH00-20K-A					
			000			13735555	FNH000-20K-A					
CFW300A04P2S120		660	00	35		10701721	FNH00-35K-A					
			000	13737105		FNH000-35K-A						
CFW300A06POS120			00	40		10702117	FNH00-40K-A					
			000	13737107		FNH000-40K-A						
CFW300A01P6S220	200...240 monofásica	166	00	20	10687494	FNH00-20K-A						
			000		13735555	FNH000-20K-A						
CFW300A02P6S220			00		10687494	FNH00-20K-A						
			000		13735555	FNH000-20K-A						
CFW300A04P2S220		660	00	25	10687494	FNH00-20K-A						
			000		13735656	FNH000-25K-A						
CFW300A06POS220			00		35	10701722	FNH00-25K-A					
			000		13737105	FNH000-35K-A						
CFW300A01P6T220	200...240 trifásica	500	00	20	10687494	FNH00-20K-A						
			000		13735555	FNH000-20K-A						
CFW300A02P6T220			00		10687494	FNH00-20K-A						
			000		13735555	FNH000-20K-A						
CFW300A04P2T220		500	00		10687494	FNH00-20K-A						
			000		13735555	FNH000-20K-A						
CFW300A06POT220			00		10687494	FNH00-20K-A						
			000		13735555	FNH000-20K-A						
CFW300A07P3T220		00	10687494	FNH00-20K-A								
	000	13735555	FNH000-20K-A									
CFW300A01P6D320	280...340	-	00	10687494	FNH00-20K-A							
		000	13735555	FNH000-20K-A								
CFW300A02P6D320		-	00	10687494	FNH00-20K-A							
		000	13735555	FNH000-20K-A								
CFW300A04P2D320		-	00	10687494	FNH00-20K-A							
		000	13735555	FNH000-20K-A								
CFW300A06POD320		-	00	10687494	FNH00-20K-A							
		000	13735555	FNH000-20K-A								
CFW300A07P3D320	-	00	10687494	FNH00-20K-A								
	000	13735555	FNH000-20K-A									
CFW300B10POB220	200...240 V ca o 280...340 V cc	300	00	35	10701721	FNH00-35K-A						
			000		13737105	FNH000-35K-A						
CFW300B15P2T220			00		10701721	FNH00-35K-A						
			000		13737105	FNH000-35K-A						

### Fusibles aR WEG Recomendados para el Convertidor WEG Modelo CFW500

CFW500		Máximo Pt del fusible	Fusible(s) WEG FNH aR contacto cuchilla recomendado(s)					Fusible(s) WEG FNHFE aR flush end recomendado(s)				
Modelo	Tensión de alimentación (V ca)	(A <sup>2</sup> s)	Tamaño	In (A)	Cantidad en paralelo	Item SAP	Referencia WEG	Tamaño	In (A)	Cantidad en paralelo	Item SAP	Referencia WEG
CFW500A01P6S2	200-240 monofásico	373	00	20	1	10687494	FNH00-20K-A					
			000			13735555	FNH000-20K-A					
CFW500A02P6S2			00			10687494	FNH00-20K-A					
			000			13735555	FNH000-20K-A					
CFW500A04P3S2		800	00	25		10701722	FNH00-25K-A					
			000	13735656		FNH000-25K-A						
CFW500A07POS2			00	40		10702117	FNH00-40K-A					
			000	13737107		FNH000-40K-A						



### Fusibles aR WEG Recomendados para el Convertidor WEG Modelo CFW500

CFW500		Máximo I <sub>t</sub> del fusible	Fusible(s) WEG FNH aR contacto cuchilla recomendado(s)					Fusible(s) WEG FNHFE aR flush end recomendado(s)																		
Modelo	Tensión de alimentación (V ca)	(A <sup>2</sup> s)	Tamaño	In (A)	Cantidad en paralelo	Item SAP	Referencia WEG	Tamaño	In (A)	Cantidad en paralelo	Item SAP	Referencia WEG														
CFW500A01P6B2	200-240 conectado en monofásico	680	00	20	1	10687494	FNH00-20K-A																			
			000			13735555	FNH000-20K-A																			
CFW500A02P6B2			00			10687494	FNH00-20K-A																			
			000			13735555	FNH000-20K-A																			
CFW500A04P3B2			00			10701722	FNH00-25K-A																			
			000			13735656	FNH000-25K-A																			
CFW500A01P6B2	200-240 conectado en trifásico		680	00		20	1						10687494	FNH00-20K-A												
				000									13735555	FNH000-20K-A												
CFW500A02P6B2				00									10687494	FNH00-20K-A												
				000									13735555	FNH000-20K-A												
CFW500A04P3B2				00									10687494	FNH00-20K-A												
				000									13735555	FNH000-20K-A												
CFW500A07P0T2	200-240 trifásico	1.250		00	25	1		10687494	FNH00-20K-A																	
				000				13735555	FNH000-20K-A																	
CFW500A09P6T2	00			10701722	FNH00-25K-A																					
	000			13735656	FNH000-25K-A																					
CFW500B07P3B2	200-240 conectado en monofásico			450	00			40	1											10702117	FNH00-40K-A					
					000															13737107	FNH000-40K-A					
CFW500B10P0B2	1		10806688		FNH1-63K-A																					
CFW500B07P3B2	200-240 conectado en trifásico		450		00		20	1							10687494	FNH00-20K-A										
					000										13735555	FNH000-20K-A										
CFW500B10P0B2	00				10701722		FNH00-25K-A																			
	000				13735656		FNH000-25K-A																			
CFW500B16P0T2	200-240 trifásico				1.000		00								40	1										
		000				13737107	FNH000-40K-A																			
CFW500C24P0T2		00				10705764	FNH00-63K-A																			
		000				13737129	FNH000-63K-A																			
CFW500D28P0T2		00				10705764	FNH00-63K-A																			
		000		13737130		FNH000-80K-A																				
CFW500D33P0T2	200-240 trifásico	2.750		00		80	1		10705995	FNH00-80K-A																
				00					13737131	FNH000-100K-A																
CFW500D47P0T2			00	10707110		FNH00-100K-A																				
			000	13737131		FNH000-100K-A																				
CFW500D56P0T2			00	10707231		FNH00-125K-A																				
			000	13737132		FNH000-125K-A																				
CFW500A01P0T4	380-480 trifásico		450	00	20	1		10687494	FNH00-20K-A																	
				000				13735555	FNH000-20K-A																	
CFW500A01P6T4				00				10687494	FNH00-20K-A																	
				000				13735555	FNH000-20K-A																	
CFW500A02P6T4				00				10687494	FNH00-20K-A																	
				000				13735555	FNH000-20K-A																	
CFW500A04P3T4		00		10687494			FNH00-20K-A																			
		000		13735555			FNH000-20K-A																			
CFW500A06P1T4		00		10687494			FNH00-20K-A																			
		000		13735555			FNH000-20K-A																			
CFW500B02P6T4		00		10687494			FNH00-20K-A																			
		000		13735555			FNH000-20K-A																			
CFW500B04P3T4		00		10687494			FNH00-20K-A																			
		000		13735555			FNH000-20K-A																			
CFW500B06P5T4		00		10687494			FNH00-20K-A																			
		000		13735555			FNH000-20K-A																			
CFW500B10P0T4		1.000		1.000			00	25	1		10701722	FNH00-25K-A														
							000				13735656	FNH000-25K-A														
CFW500C13P0T4							00	10701721			FNH00-35K-A															
							000	13737105			FNH000-35K-A															
CFW500C16P0T4							00	10701721			FNH00-35K-A															
							000	13737105			FNH000-35K-A															

Nota:  Para esta aplicación, los fusibles no pueden ser montados en seccionadoras FSW o RFW, solamente en bases de fijación individual BNH.

### Fusibles aR WEG Recomendados para el Convertidor WEG Modelo CFW500

CFW500		Máximo Pt del fusible	Fusible(s) WEG FNH aR contacto cuchilla recomendado(s)				Fusible(s) WEG FNHFE aR flush end recomendado(s)						
Modelo	Tensión de alimentación (V ca)	(A²s)	Tamaño	In (A)	Cantidad en paralelo	Item SAP	Referencia WEG	Tamaño	In (A)	Cantidad en paralelo	Item SAP	Referencia WEG	
CFW500D24P0T4	380-480 trifásico	1.800	00	63	1	10705764	FNH00-63K-A						
CFW500D31P0T4			000			13737129	FNH000-63K-A						
			00			10705764	FNH00-63K-A						
			000			13737129	FNH000-63K-A						
CFW500E39P0T4		2.100	00	80		10705995	FNH00-80K-A						
			000	80		13737130	FNH000-80K-A						
CFW500E49P0T4		13.000	00	100		10707110	FNH00-100K-A						
			000	125		13737132	FNH000-125K-A						
CFW500C01P7T5		500-600 trifásico	1.000	00		20	10687494						FNH00-20K-A
CFW500C03P0T5				000			13735555						FNH000-20K-A
	00			10687494	FNH00-20K-A								
	000			13735555	FNH000-20K-A								
CFW500C04P3T5	00			10687494	FNH00-20K-A								
	000			13735555	FNH000-20K-A								
CFW500C07P0T5	00			10687494	FNH00-20K-A								
	000			13735555	FNH000-20K-A								
CFW500C10P0T5	25			00	10701722	FNH00-25K-A							
				000	13735656	FNH000-25K-A							
CFW500C12P0T5	00			10701722	FNH00-25K-A								
	000			13735656	FNH000-25K-A								

Nota:  Para esta aplicación, los fusibles no pueden ser montados en seccionadoras FSW o RFW, solamente en bases de fijación individual BNH.



**Fusibles aR WEG Recomendados para el Convertidor WEG Modelo CFW501**

CFW501			Maximum I <sub>rt</sub> of the fuse	Fusible(s) WEG FNH aR contacto cuchilla recomendado(s)					Fusible(s) WEG FNHFE aR flush end recomendado(s)												
Modelo	Mecánica	Tensión de alimentación (V ca)	(A <sup>2</sup> s)	Tamaño	In (A)	Cantidad en paralelo	Item SAP	Referencia WEG	Tamaño	In (A)	Cantidad en paralelo	Item SAP	Referencia WEG								
CFW501A01P6T2	A	200 - 240	680	00	20	1	10687494	FNH00-20K-A													
				000			13735555	FNH000-20K-A													
CFW501A02P6T2				00			10687494	FNH00-20K-A													
				000			13735555	FNH000-20K-A													
CFW501A04P3T2				00			10687494	FNH00-20K-A													
				000			13735555	FNH000-20K-A													
CFW501A07P0T2				00			10687494	FNH00-20K-A													
	000	13735555	FNH000-20K-A																		
CFW501A09P6T2	B	200 - 240	1.250	00	25	1	10701722	FNH00-25K-A													
				000			13735656	FNH000-25K-A													
CFW501B07P3T2			00	10687494	FNH00-20K-A																
			000	13735555	FNH000-20K-A																
CFW501B10P0T2			00	10701722	FNH00-25K-A																
			000	13735656	FNH000-25K-A																
CFW501B16P0T2			00	10702117	FNH00-40K-A																
			000	13737107	FNH000-40K-A																
CFW501C24P0T2			00	10705764	FNH00-63K-A																
			000	13737129	FNH000-63K-A																
CFW501A01P0T4			A	Trifásica	450		00	20						1	10687494	FNH00-20K-A					
							000								13735555	FNH000-20K-A					
CFW501A01P6T4							00								10687494	FNH00-20K-A					
							000								13735555	FNH000-20K-A					
CFW501A02P6T4	00	10687494				FNH00-20K-A															
	000	13735555				FNH000-20K-A															
CFW501A04P3T4	00	10687494				FNH00-20K-A															
	000	13735555				FNH000-20K-A															
CFW501A06P1T4	00	10687494				FNH00-20K-A															
	000	13735555				FNH000-20K-A															
CFW501B02P6T4	00	10687494				FNH00-20K-A															
	000	13735555				FNH000-20K-A															
CFW501B04P3T4	00	10687494				FNH00-20K-A															
	000	13735555				FNH000-20K-A															
CFW501B06P5T4	00	10687494				FNH00-20K-A															
	000	13735555				FNH000-20K-A															
CFW501B10P0T4	00	10701722				FNH00-25K-A															
	000	13735656				FNH000-25K-A															
CFW501C14P0T4	C	1.000	1.000	00	35	1	10701721	FNH00-35K-A													
				000			13737105	FNH000-35K-A													
CFW501C16P0T4				00			10701721	FNH00-35K-A													
				000			13737105	FNH000-35K-A													
CFW501D24P0T4	D	1.800	1.800	00	63	1	10705764	FNH00-63K-A													
				000			13737129	FNH000-63K-A													
CFW501D31P0T4				00			10705995	FNH00-80K-A													
	000	13737130	FNH000-80K-A																		

### Fusibles aR WEG Recomendados para el Convertidor WEG Modelo CFW700

CFW700				Máximo I <sup>pt</sup> del fusible			
Modelo	Mecánica	IGBT de frenado	Tensión de alimentación (V ca)	(A <sup>2</sup> s)			
CFW700B33P5T2DB20H1ACS1	B	-	220-230	1.000			
CFW700C70P0T2DB20H1ACS1	C			2.750			
CFW700D0105T2DBN1H1ACS1	D			3.150			
CFW700E0211T2DB20C3H1ACS1	E			218.000			
CFW700B31P0T4DB20H1ACS1	B		380-480	1.250			
CFW700C58P5T4DB20H1ACS1	C			2.100			
CFW700D88P0T4DBN1H1ACS1	D			3.150			
CFW700E0211T4DB20C3H1ACS1	E			218.000			
CFW700A10P0S2DB	A	Incorporado (interno)	220	1.000			
CFW700A06P0B2DB				Monofásico o trifásico	420		
CFW700A07P0B2DB							
CFW700A07P0T2DB				Trifásico			
CFW700A10P0T2DB							
CFW700A13P0T2DB							
CFW700A16P0T2DB							
CFW700B24P0T2DB						B	1.000
CFW700B28P0T2DB							
CFW700B33P5T2DB							
CFW700C45P0T2DB	C	2.750					
CFW700C54P0T2DB							
CFW700C70P0T2DB							
CFW700D86P0T2DB			D	3.150			
CFW700D0105T2DB							
CFW700E0142T2NB	E	No incorporado	39.200				
CFW700E0180T2NB		Incorporado (interno)	218.000				
CFW700E0211T2NB			39.200				
CFW700E0142T2DB			218.000				
CFW700E0180T2DB			A	380	190		
CFW700E0211T2DB							
CFW700A03P6T4DB							
CFW700A05P0T4DB	B	Incorporado (interno)	380	495			
CFW700A07P0T4DB							
CFW700A10P0T4DB							
CFW700A13P5T4DB				500			
CFW700B17P0T4DB							
CFW700B24P0T4DB							
CFW700B31P0T4DB	1.250						

Nota:   Para esta aplicación, los fusibles no pueden ser montados en seccionadoras FSW o RFW, solamente en bases de fijación individual BNH.

Fusible(s) WEG FNH aR contacto cuchilla recomendado(s)						Fusible(s) WEG FNHFE aR flush end recomendado(s)				
Tamaño	In (A)	Cantidad en paralelo	Item SAP	Referencia WEG	Tamaño	In (A)	Cantidad en paralelo	Item SAP	Referencia WEG	
00	63	1	10705764	FNH00-63K-A	-	-	-	-	-	
000			13737129	FNH000-63K-A						
00	100	1	10707110	FNH00-100K-A	-	-	-	-	-	
00			10701724	FNH00-160K-A						
1	400	1	10815073	FNH1-400K-A	3	450	1	12644962	FNH3FEM-450Y-A	
00	50	1	10701718	FNH00-50K-A	-	-	-	-	-	
000			13737128	FNH000-50K-A						
00			10705995	FNH00-80K-A						
000	80	1	13737130	FNH000-80K-A	-	-	-	-	-	
00	125	1	10707231	FNH00-125K-A						
1	400	1	10815073	FNH1-400K-A	3	450	1	12644962	FNH3FEM-450Y-A	
00	25	1	10701722	FNH00-25K-A	-	-	-	-	-	
000			13735656	FNH000-25K-A						
00	20	1	10687494	FNH00-20K-A	-	-	-	-	-	
000			13735555	FNH000-20K-A						
00			10687494	FNH00-20K-A						
000			13735555	FNH000-20K-A						
00			10687494	FNH00-20K-A						
000			13735555	FNH000-20K-A						
00	25	1	10701722	FNH00-25K-A	-	-	-	-	-	
000			13735656	FNH000-25K-A						
00			10701722	FNH00-25K-A						
000	35	1	13735656	FNH000-25K-A	-	-	-	-	-	
00			10701721	FNH00-35K-A						
000			13737105	FNH000-35K-A						
00	40	1	10702117	FNH00-40K-A	-	-	-	-	-	
000			13737107	FNH000-40K-A						
00	40	1	10702117	FNH00-40K-A	-	-	-	-	-	
000			13737107	FNH000-40K-A						
00	50	1	10701718	FNH00-50K-A	-	-	-	-	-	
000			13737128	FNH000-50K-A						
00	80	1	10705995	FNH00-80K-A	-	-	-	-	-	
000			13737130	FNH000-80K-A						
00			10705995	FNH00-80K-A						
000	100	1	13737131	FNH000-100K-A	-	-	-	-	-	
00			10707110	FNH00-100K-A						
00	125	1	10707231	FNH00-125K-A	-	-	-	-	-	
1	250	1	10809489	FNH1-250K-A						
	315		10809575	FNH1-315K-A						
	350		10814896	FNH1-350K-A						
	250		10809489	FNH1-250K-A						
	315		10809575	FNH1-315K-A						
350	10814896	FNH1-350K-A								
00	20	1	10687494	FNH00-20K-A	-	-	-	-	-	
000			13735555	FNH000-20K-A						
00			10687494	FNH00-20K-A						
000			13735555	FNH000-20K-A						
00			10687494	FNH00-20K-A						
000			13735555	FNH000-20K-A						
00	25	1	10701722	FNH00-25K-A	-	-	-	-	-	
000			13735656	FNH000-25K-A						
00			10701722	FNH00-25K-A						
000	35	1	13735656	FNH000-25K-A	-	-	-	-	-	
00			10701721	FNH00-35K-A						
000	40	1	13737105	FNH000-35K-A	-	-	-	-	-	
00			10702117	FNH00-40K-A						
000	50	1	13737107	FNH000-40K-A	-	-	-	-	-	
00			10701718	FNH00-50K-A						
000	50	1	13737128	FNH000-50K-A	-	-	-	-	-	

### Fusibles aR WEG Recomendados para el Convertidor WEG Modelo CFW700

CFW700				Máximo I <sup>2</sup> t del fusible	
Modelo	Mecánica	IGBT de frenado	Tensión de alimentación (V ca)	(A <sup>2</sup> s)	
CFW700C38P0T4DB	C	Incorporado (interno)	380	1.250	
CFW700C45P0T4DB				2.100	
CFW700C58P5T4DB				3.150	
CFW700D70P5T4DB	D	No incorporado		39.200	
CFW700D88P0T4DB				218.000	
CFW700E0105T4NB	E			Incorporado (interno)	39.200
CFW700E0142T4NB					218.000
CFW700E0180T4NB					39.200
CFW700E0211T4NB					218.000
CFW700E0105T4DB					218.000
CFW700E0142T4DB					218.000
CFW700E0180T4DB	A			Incorporado (interno)	190
CFW700E0211T4DB			495		
CFW700A03P6T4DB			B		500
CFW700A05P0T4DB					1.250
CFW700A07P0T4DB		2.100			
CFW700A10P0T4DB		3.150			
CFW700A13P5T4DB	39.200				
CFW700B17P0T4DB	C	No incorporado	218.000		
CFW700B24P0T4DB			39.200		
CFW700B31P0T4DB			218.000		
CFW700C38P0T4DB	D		Incorporado (interno)		39.200
CFW700C45P0T4DB					218.000
CFW700C58P5T4DB				39.200	
CFW700D70P5T4DB	E			Incorporado (interno)	218.000
CFW700D88P0T4DB					39.200
CFW700E0105T4NB					218.000
CFW700E0142T4NB					39.200
CFW700E0180T4NB					218.000
CFW700E0211T4NB					218.000
CFW700E0105T4DB	B	Incorporado (interno)		39.200	
CFW700E0142T4DB				218.000	
CFW700E0180T4DB				39.200	
CFW700E0211T4DB			218.000		
CFW700B02P9T5DB			B	Incorporado (interno)	1.250
CFW700B04P2T5DB					1.250
CFW700B07P0T5DB	1.250				
CFW700B10P0T5DB	1.250				
CFW700B12P0T5DB	1.250				
CFW700B17P0T5DB	1.250				

Fusible(s) WEG FNH aR contacto cuchilla recomendado(s)						Fusible(s) WEG FNHFE aR flush end recomendado(s)								
Tamaño	In (A)	Cantidad en paralelo	Item SAP	Referencia WEG	Tamaño	In (A)	Cantidad en paralelo	Item SAP	Referencia WEG					
00	63	1	10705764	FNH00-63K-A	-	-	-	-	-					
000			13737129	FNH000-63K-A										
00			10705764	FNH00-63K-A										
000	80		13737130	FNH000-80K-A										
			10705995	FNH00-80K-A										
			10707110	FNH00-100K-A										
00	10707231		FNH00-125K-A											
	160		10701724	FNH00-160K-A										
	250		10809489	FNH1-250K-A										
1	315		10809575	FNH1-315K-A						3	450	1	12644962	FNH3FEM-450Y-A
	350		10814896	FNH1-350K-A						-	-	-	-	-
	160		10701724	FNH00-160K-A										
250	10809489		FNH1-250K-A											
1	315		10809575	FNH1-315K-A						3	450	1	12644962	FNH3FEM-450Y-A
	350		10814896	FNH1-350K-A						-	-	-	-	-
	00		10687494	FNH00-20K-A										
000	13735555		FNH000-20K-A											
00	10687494		FNH00-20K-A											
000	13735555	FNH000-20K-A												
00	10687494	FNH00-20K-A												
000	13735555	FNH000-20K-A												
00	10701722	FNH00-25K-A												
000	13735656	FNH000-25K-A												
00	10701722	FNH00-25K-A												
000	13735656	FNH000-25K-A												
00	10701721	FNH00-35K-A												
000	13737105	FNH000-35K-A												
00	10702117	FNH00-40K-A												
000	13737107	FNH000-40K-A												
00	10701718	FNH00-50K-A												
000	13737128	FNH000-50K-A												
00	10705764	FNH00-63K-A												
000	13737129	FNH000-63K-A												
00	10705764	FNH00-63K-A												
000	13737130	FNH000-80K-A												
00	100	10705995	FNH00-80K-A											
		10707110	FNH00-100K-A											
		10707231	FNH00-125K-A											
00	160	10701724	FNH00-160K-A											
1	250	10809489	FNH1-250K-A	3	450	1	12644962	FNH3FEM-450Y-A						
	315	10809575	FNH1-315K-A	-	-	-	-	-						
	350	10814896	FNH1-350K-A											
160	10701724	FNH00-160K-A												
1	250	10809489	FNH1-250K-A	3	450	1	12644962	FNH3FEM-450Y-A						
	315	10809575	FNH1-315K-A	-	-	-	-	-						
	350	10814896	FNH1-350K-A											
00	10687494	FNH00-20K-A												
000	13735555	FNH000-20K-A												
00	10687494	FNH00-20K-A												
000	13735555	FNH000-20K-A												
00	10687494	FNH00-20K-A												
000	13735555	FNH000-20K-A												
00	10687494	FNH00-20K-A												
000	13735555	FNH000-20K-A												
00	10701722	FNH00-25K-A												
000	13735656	FNH000-25K-A												
00	10701721	FNH00-35K-A												
000	13737105	FNH000-35K-A												

### Fusibles aR WEG Recomendados para el Convertidor WEG Modelo CFW700

CFW700				Máximo I <sup>2</sup> t del fusible				
Modelo	Mecánica	IGBT de frenado	Tensión de alimentación (V ca)	(A <sup>2</sup> s)				
CFW700C22P0T5	C	Incorporado (interno)	600	Trifásico	2.100			
CFW700C27P0T5								
CFW700C32P0T5								
CFW700C44P0T5								
CFW700D22P0T5DB	D				Incorporado (interno)	600	Trifásico	7.200
CFW700D27P0T5DB								
CFW700D32P0T5DB								
CFW700D44P0T5DB								
CFW700E53P0T5NB	E	No incorporado	600	Trifásico				39.200
CFW700E63P0T5NB								
CFW700E80P0T5NB								
CFW700E0107T5NB								
CFW700E0125T5NB								
CFW700E0150T5NB		218.000						
CFW700E53P0T5DB		Incorporado (interno)			600	Trifásico	39.200	
CFW700E63P0T5DB								
CFW700E80P0T5DB								
CFW700E0107T5DB								
CFW700E0180T4DB	218.000							
CFW700E0211T4DB								

### Fusibles aR WEG Recomendados para el Convertidor WEG Modelo CFW701

CFW701				Máximo I <sup>2</sup> t del fusible			
Modelo	Mecánica	Tensión de alimentación (V ca)	Número de fases	(A <sup>2</sup> s)			
CFW700C22P0T5	A	220...240	1	420			
CFW700C27P0T5							
CFW700C32P0T5					1.000		
CFW700C44P0T5			A	220...240	3	420	
CFW701A10P0T2							
CFW701A13P0T2							
CFW701A16P0T2							
CFW701B24P0T2	B	3					1.000
CFW701B28P0T2							
CFW701B33P5T2							



Fusible(s) WEG FNH aR contacto cuchilla recomendado(s)						Fusible(s) WEG FNHFE aR flush end recomendado(s)				
Tamaño	In (A)	Cantidad en paralelo	Item SAP	Referencia WEG	Tamaño	In (A)	Cantidad en paralelo	Item SAP	Referencia WEG	
00	40	1	10702117	FNH00-40K-A	-	-	-	-	-	
000			13737107	FNH000-40K-A						
00	50		10701718	FNH00-50K-A						
000			13737128	FNH000-50K-A						
00	63		10705764	FNH00-63K-A						
000			13737129	FNH000-63K-A						
00	80		10705995	FNH00-80K-A						
000			13737130	FNH000-80K-A						
00	40		10702117	FNH00-40K-A						
000			13737107	FNH000-40K-A						
00	50		10701718	FNH00-50K-A						
000			13737128	FNH000-50K-A						
00	63		10705764	FNH00-63K-A						
000			13737129	FNH000-63K-A						
00	80		10705995	FNH00-80K-A						
000			13737130	FNH000-80K-A						
00	100		10705995	FNH00-80K-A						
000			13737131	FNH000-100K-A						
00	125		10707110	FNH00-100K-A						
000			13737132	FNH000-125K-A						
00	160		10707231	FNH00-125K-A						
00	200		10701724	FNH00-160K-A						
1	250		10710732	FNH00-200K-A						
00	80		10809489	FNH1-250K-A						
000	100	10705995	FNH00-80K-A							
00		13737131	FNH000-100K-A							
000	125	10707110	FNH00-100K-A							
00		13737132	FNH000-125K-A							
00	160	10707231	FNH00-125K-A							
00	200	10701724	FNH00-160K-A							
1	250	10710732	FNH00-200K-A							
1	250	10809489	FNH1-250K-A							
3	450	1	12644962	FNH3FEM-450Y-A						
-	-	-	-	-	-	-	-	-	-	
3	450	1	12644962	FNH3FEM-450Y-A						

Fusible(s) WEG FNH aR contacto cuchilla recomendado(s)						Fusible(s) WEG FNHFE aR flush end recomendado(s)				
Tamaño	In (A)	Cantidad en paralelo	Item SAP	Referencia WEG	Tamaño	In (A)	Cantidad en paralelo	Item SAP	Referencia WEG	
00	20	1	10687494	FNH00-20K-A	-	-	-	-	-	
000			13735555	FNH000-20K-A						
00	25		10687494	FNH00-20K-A						
000			13735656	FNH000-25K-A						
00	35		10701722	FNH00-25K-A						
000			13737105	FNH000-35K-A						
00	20		10687494	FNH00-20K-A						
000			13735555	FNH000-20K-A						
00	25		10701722	FNH00-25K-A						
000			13735555	FNH000-20K-A						
00	20		13735555	FNH000-20K-A						
00			10701722	FNH00-25K-A						
000	25		13735656	FNH000-25K-A						
00			10701721	FNH00-35K-A						
000	35		13737105	FNH000-35K-A						
00			10702117	FNH00-40K-A						
000	40		13737107	FNH000-40K-A						
00			10702117	FNH00-40K-A						
000	50		13737107	FNH000-40K-A						
00			10701718	FNH00-50K-A						
000	63		13737129	FNH000-63K-A						

**Fusibles aR WEG Recomendados para el Convertidor WEG Modelo CFW701**

CFW701				Máximo I <sup>2</sup> t del fusible	
Modelo	Mecánica	Tensión de alimentación (V ca)	Número de fases	(A <sup>2</sup> s)	
CFW701C45POT2	C	220...240	3	2.750	
CFW701C54POT2					
CFW701C70POT2					
CFW701D86POT2	D				3.150
CFW701D0105T2					
CFW701E0142T2	E	220/230			39.200
CFW701E0180T2					
CFW701E0211T2					
CFW701A03P6T4	A				190
CFW701A05POT4					
CFW701A07POT4					
CFW701A10POT4					
CFW701A13P5T4					
CFW701B17POT4	B	380...480			495
CFW701B24POT4					
CFW701B31POT4					
CFW701C38POT4	C				500
CFW701C45POT4					
CFW701C58P5T4					
CFW701D70P5T4					
CFW701D88POT4					
CFW701E0105T4					
CFW701E0142T4	E				1.250
CFW701E0180T4					
CFW701E0211T4					
CFW701B02P9T5					
CFW701B04P2T5	B	500...600			2.100
CFW701B07POT5					
CFW701B10POT5					
CFW701B12POT5					
CFW701B17POT5					
CFW701C22POT5			C		
CFW701C27POT5					
CFW701C32POT5					
CFW701C44POT5					
CFW701C32POT5	C			39.200	
CFW701E0180T4					
CFW701E0211T4					
CFW701B02P9T5					
CFW701B04P2T5	B	500...600		218.000	
CFW701B07POT5					
CFW701B10POT5					
CFW701B12POT5					
CFW701B17POT5					
CFW701C22POT5					C
CFW701C27POT5					
CFW701C32POT5					
CFW701C44POT5					

Nota:   Para esta aplicación, los fusibles no pueden ser montados en seccionadoras FSW o RFW, solamente en bases de fijación individual BNH.

Fusible(s) WEG FNH aR contacto cuchilla recomendado(s)						Fusible(s) WEG FNHFE aR flush end recomendado(s)													
Tamaño	In (A)	Cantidad en paralelo	Item SAP	Referencia WEG	Tamaño	In (A)	Cantidad en paralelo	Item SAP	Referencia WEG										
00	80	1	10705995	FNH00-80K-A	-	-	-	-	-										
000			13737130	FNH000-80K-A															
00			10705995	FNH00-80K-A															
000	100		13737131	FNH000-100K-A															
00			10707110	FNH00-100K-A															
000			13737131	FNH000-100K-A															
00	125		10707231	FNH00-125K-A						3	450	1	12644962	FNH3FEM-450Y-A					
00			10707231	FNH00-125K-A															
00			10809489	FNH1-250K-A															
1	315		10809575	FNH1-315K-A															
00	20	10814896	FNH1-350K-A	-	-	-	-	-											
000		10687494	FNH00-20K-A																
00		13735555	FNH000-20K-A																
000		10687494	FNH00-20K-A																
00		13735555	FNH000-20K-A																
000		10687494	FNH00-20K-A																
00		13735555	FNH000-20K-A																
00		25	10701722						FNH00-25K-A										
000			13735656						FNH000-25K-A										
00			10701722						FNH00-25K-A										
000	35	13735656	FNH000-25K-A	-	-	-	-	-											
00		10701721	FNH00-35K-A																
000		13737105	FNH000-35K-A																
00	40	10702117	FNH00-40K-A						-	-	-	-	-						
000		13737107	FNH000-40K-A																
00		10702117	FNH00-40K-A																
000	50	13737128	FNH000-50K-A											3	450	1	12644962	FNH3FEM-450Y-A	
00		10701718	FNH00-50K-A																
000		13737129	FNH000-63K-A																
00	63	10705764	FNH00-63K-A																-
000		13737130	FNH000-80K-A																
00		10705995	FNH00-80K-A																
000	80	13737130	FNH000-80K-A	-	-	-	-	-											
1		100	10807553						FNH1-100K-A										
00		125	10707231						FNH00-125K-A										
00	160	10701724	FNH00-160K-A																
1	250	10809489	FNH1-250K-A																
1	315	10809575	FNH1-315K-A																
1	400	10815073	FNH1-400K-A																
00	20	10687494	FNH00-20K-A						-	-	-	-	-						
000		13735555	FNH000-20K-A																
00		10687494	FNH00-20K-A																
000		13735555	FNH000-20K-A																
00		10687494	FNH00-20K-A																
000		13735555	FNH000-20K-A																
00		10687494	FNH00-20K-A																
000		13735555	FNH000-20K-A																
00		25	10701722	FNH00-25K-A	-	-	-	-						-					
000			13735656	FNH000-25K-A															
00	10701721		FNH00-35K-A																
000	35	13737105	FNH000-35K-A	-					-	-	-	-							
00		10702117	FNH00-40K-A																
000		13737107	FNH000-40K-A																
00	40	10702117	FNH00-40K-A										-		-	-	-	-	
000		13737107	FNH000-40K-A																
00		10701718	FNH00-50K-A																
000	50	13737128	FNH000-50K-A																-
00		10701718	FNH00-50K-A																
000		13737128	FNH000-50K-A																
00	63	10705764	FNH00-63K-A		-	-	-	-						-					
000		13737129	FNH000-63K-A																
00		10705995	FNH00-80K-A																
000	80	10705995	FNH00-80K-A	-					-	-	-	-							
000		13737130	FNH000-80K-A																

### Fusibles aR WEG Recomendados para el Convertidor WEG Modelo CFW701

CFW701				Máximo I <sup>2</sup> t del fusible
Modelo	Mecánica	Tensión de alimentación (V ca)	Número de fases	(A <sup>2</sup> s)
CFW701D22P0T5	D	500...600	3	7.200
CFW701D27P0T5				
CFW701D32P0T5				
CFW701D44P0T5				
CFW701E53P0T5	E			39.200
CFW701E63P0T5				
CFW701E80P0T5				
CFW701E0107T5				
CFW701E0125T5				
CFW701E0150T5				

### Fusibles aR WEG Recomendados para el Convertidor WEG Modelo MW500

MW500				Máximo I <sup>2</sup> t del fusible	Fusible(s) WEG FNH aR contacto cuchilla recomendado(s)				Fusible(s) WEG FNHFE aR flush end recomendado(s)					
Modelo	Mecánica	Tensión de alimentación (V ca)		(A <sup>2</sup> s)	Tamaño	In (A)	Cantidad en paralelo	Item SAP	Referencia WEG	Tamaño	In (A)	Cantidad en paralelo	Item SAP	Referencia WEG
MW500A0493S2	A	200-240	Monofásico	373	00	20	1	10687494	FNH00-20K-A	-	-	-	-	-
MW500A06P0S2					000			13735555	FNH000-20K-A					
MW500A02P6T4					00			10701722	FNH00-25K-A					
MW500A04P3T4		380-480	Trifásico	450	000	13735656		FNH000-25K-A						
					00	10687494		FNH00-20K-A						
					000	13735555		FNH000-20K-A						
MW500B06P5T4	B	380-480	Trifásico	450	00	20	10687494	FNH00-20K-A	-	-	-	-	-	
000					13735555		FNH000-20K-A							
00					10687494		FNH00-20K-A							
MW500B10P0T4	B	380-480	Trifásico	1.000	00	25	10701722	FNH00-25K-A	-	-	-	-	-	
000					13735656		FNH000-25K-A							

### Fusibles aR WEG Recomendados para el Filtro Activo WEG Modelo FAW700

FAW700				Máximo I <sup>2</sup> t del fusible	Fusible(s) WEG FNH aR contacto cuchilla recomendado(s)				Fusible(s) WEG FNHFE aR flush end recomendado(s)					
Modelo	Mecánica	Tensión de alimentación (V ca)		(A <sup>2</sup> s)	Tamaño	In (A)	Cantidad en paralelo	Item SAP	Referencia WEG	Tamaño	In (A)	Cantidad en paralelo	Item SAP	Referencia WEG
FAW700G230T420	G	380-480	Trifásico	49.000	1	400	1	10815073	FNH1-400K-A	3	450	1	12644962	FNH3FEM-450Y-A

### Fusibles aR WEG Recomendados para el Circuito de Entrada del Convertidor CA/CC WEG Modelo CTW900

CFW900		Fusibles recomendados para a protección del circuito de entrada de la armadura (lado CA)									
Modelo	Máximo I <sup>2</sup> t del fusible (A <sup>2</sup> s)	Fusible(s) WEG FNH aR contacto cuchilla recomendado(s)				Fusible(s) WEG FNHFE aR flush end recomendado(s)					
		Tamaño	In (A)	Referencia WEG	Item SAP	Tamaño	In (A)	Referencia WEG	Item SAP		
20 A	6.000	00	25	FNH00-25K-A	10701722	-	-	-	-		
50 A		000	25	FNH000-25K-A	13735656						
		00	63	FNH00-63K-A	10705764						
90 A	8.000	00	80	FNH000-80K-A	13737130	-	-	-	-		
125 A	11.000		125	FNH00-125K-A	10707231						
180 A	73.000		160	FNH00-160K-A	10701724						
260 A	63.000	1	250	FNH00-250K-A	10711445	3	450	FNH3FEM-450Y-A	12644962		
480 A	240.000		350	FNH1-350K-A	10814896						
640 A	300.000		710	FNH2-710K-A	11393547						
1.000 A	900.000	3	800	FNH3-800K-A	10833726	700	FNH3FEM-700Y-A	12660657			
1.500 A	-	-	-	-	-	1.100	FNH3FEM-1100Y-A	12661664			
2.000 A		Disyuntor para protección del circuito. Utiliza fusibles WEG en el interior del producto									

Nota: Para esta aplicación, los fusibles no pueden ser montados en seccionadoras FSW o RFW, solamente en bases de fijación individual BNH.

Fusible(s) WEG FNH aR contacto cuchilla recomendado(s)						Fusible(s) WEG FNHFE aR flush end recomendado(s)				
Tamaño	In (A)	Cantidad en paralelo	Item SAP	Referencia WEG	Tamaño	In (A)	Cantidad en paralelo	Item SAP	Referencia WEG	
00	40	1	10702117	FNH00-40K-A	-	-	-	-	-	
000			13737107	FNH000-40K-A						
00	50		10701718	FNH00-50K-A						
000			13737128	FNH000-50K-A						
00	63		10705764	FNH00-63K-A						
000			13737129	FNH000-63K-A						
00	80		10705995	FNH00-80K-A						
000			13737130	FNH000-80K-A						
00	100		10707110	FNH00-100K-A						
000			13737131	FNH000-100K-A						
00	125		10707110	FNH00-100K-A						
000			13737132	FNH000-125K-A						
00	125	10707231	FNH00-125K-A							
000		13737132	FNH000-125K-A							
00	160	10701724	FNH00-160K-A							
00	200	10710732	FNH00-200K-A							
1	250	10809489	FNH1-250K-A	3	450	1	12644962	FNH3FEM-450Y-A		

### Fusibles aR WEG Recomendados para el Circuito de Campo del Convertidor CA/CC WEG Modelo CTW900

CTW900		Fusibles recomendados para la protección del circuito de campo				CTW900		Fusibles recomendados para la protección del circuito de campo			
Modelo (A)	Máximo I <sup>2</sup> t del fusible (A <sup>2</sup> s)	Fusible(s) WEG FNH aR contacto cuchilla recomendado(s)				Modelo (A)	Máximo I <sup>2</sup> t del fusible (A <sup>2</sup> s)	Fusible(s) WEG FNH aR contacto cuchilla recomendado(s)			
		Tamaño	In (A)	Referencia WEG	Item SAP			Tamaño	In (A)	Referencia WEG	Item SAP
20	435	00	20	FNH00-20K-A	10687494	480	510	00	35	FNH00-35K-A	10701721
		000		FNH000-20K-A	13735555			000		FNH000-35K-A	13737105
00		FNH00-20K-A		10687494	00			FNH00-35K-A		10701721	
000		FNH000-20K-A		13735555	000			FNH000-35K-A		13737105	
00		FNH00-20K-A		10687494	00			FNH00-35K-A		10701721	
000		FNH000-20K-A		13735555	000			FNH000-35K-A		13737105	
00		25	FNH00-20K-A	10687494	00			FNH00-35K-A	10701721		
000			FNH000-20K-A	13735555	000			FNH000-35K-A	13737105		
00			FNH00-25K-A	10701722	00			FNH00-35K-A	10701721		
000			FNH000-25K-A	13735656	000			FNH000-35K-A	13737105		
00			FNH00-25K-A	10701722	00			FNH00-35K-A	10701721		
000			FNH000-25K-A	13735656	000			FNH000-35K-A	13737105		
260											

Fusibles recomendados para la protección del circuito de salida de la armadura (para convertidores 4-Q)											
Fusible(s) WEG FNH aR contacto cuchilla recomendado(s)					Fusible(s) WEG FNHFE aR flush end recomendado(s)						
Tamaño	In (A)	Referencia WEG	Item SAP	Tamaño	In (A)	WEG reference	SAP code				
00	35	FNH00-35K-A	10701721	-	-	-	-				
000	35	FNH000-35K-A	13737105								
00	63	FNH00-63K-A	10705764								
000	80	FNH000-80K-A	13737130								
00	125	FNH00-125K-A	10707231								
1	200	FNH1-200K-A	10809133								
	315	FNH1-315K-A	10809575								
3	400	FNH3-400K-A	10831217								
	710	FNH3-710K-A	10833591								
-	-	-	-					3	630	FNH3FEM-630Y-A	12660583
									800	FNH3FEM-800Y-A	12661660
									1.100	FNH3FEM-1100Y-A	12661664

Disyuntor para protección del circuito. Utiliza fusibles WEG en el interior del producto





# La presencia global es esencial. Entender lo que usted necesita también.

## Presencia Global

Con más de 30.000 colaboradores en todo el mundo, somos uno de los mayores productores mundiales de motores eléctricos, equipos y sistemas electro-electrónicos. Estamos constantemente expandiendo nuestro portafolio de productos y servicios con conocimiento especializado y de mercado. Creamos soluciones integradas y personalizadas que van desde productos innovadores hasta asistencia postventa completa.

Con el *know-how* de WEG, los **aR Fuses** son la elección adecuada para su aplicación y su negocio, con seguridad, eficiencia y confiabilidad.

 **Disponibilidad** es contar con una red global de servicios

 **Alianza** es crear soluciones que satisfagan sus necesidades

 **Competitividad** es unir tecnología e innovación



# Conozca



Productos de alto desempeño y confiabilidad para mejorar su proceso productivo



Excelencia es desarrollar soluciones que aumentan la productividad de nuestros clientes, con una línea completa para automatización industrial.

Acceda a: [www.weg.net](http://www.weg.net)

 [youtube.com/wegvideos](https://youtube.com/wegvideos)

# Sucursales WEG en el Mundo

## ALEMANIA

Türnich - Kerpen  
Teléfono: +49 2237 92910  
[info-de@weg.net](mailto:info-de@weg.net)

Balingen - Baden-Württemberg  
Teléfono: +49 7433 90410  
[info@weg-antriebe.de](mailto:info@weg-antriebe.de)

## ARGENTINA

San Francisco - Córdoba  
Teléfono: +54 3564 421484  
[info-ar@weg.net](mailto:info-ar@weg.net)

Córdoba - Córdoba  
Teléfono: +54 3514 641366  
[weg-morbe@weg.com.ar](mailto:weg-morbe@weg.com.ar)

Buenos Aires  
Teléfono: +54 1142 998000  
[ventas@pulverlux.com.ar](mailto:ventas@pulverlux.com.ar)

## AUSTRALIA

Scoresby - Victoria  
Teléfono: +61 3 97654600  
[info-au@weg.net](mailto:info-au@weg.net)

## AUSTRIA

Markt Piesting - Wiener  
Neustadt-Land  
Teléfono: +43 2 633 4040  
[watt@wattdrive.com](mailto:watt@wattdrive.com)

Vienna  
Teléfono: +43 1 796 2048  
[wtr@weg.net](mailto:wtr@weg.net)

## BÉLGICA

Nivelles - Bélgica  
Teléfono: +32 67 888420  
[info-be@weg.net](mailto:info-be@weg.net)

## BRASIL

Jaraguá do Sul - Santa Catarina  
Teléfono: +55 47 32764000  
[info-br@weg.net](mailto:info-br@weg.net)

## CHILE

La Reina - Santiago  
Teléfono: +56 2 27848900  
[info-cl@weg.net](mailto:info-cl@weg.net)

## CHINA

Nantong - Jiangsu  
Teléfono: +86 513 85989333  
[info-cn@weg.net](mailto:info-cn@weg.net)

## CHINA

Changzhou - Jiangsu  
Teléfono: +86 519 88067692  
[info-cn@weg.net](mailto:info-cn@weg.net)

Rugao - Jiangsu  
Teléfono: +86 513 80672011  
[zhuhua@weg.net](mailto:zhuhua@weg.net)

## COLOMBIA

San Cayetano - Bogotá  
Teléfono: +57 1 4160166  
[info-co@weg.net](mailto:info-co@weg.net)

Sabaneta - Antioquia  
Teléfono: +57 4 4449277  
[info-co@weg.net](mailto:info-co@weg.net)

## ECUADOR

El Batán - Quito  
Teléfono: +593 2 5144339  
[wegecuador@weg.net](mailto:wegecuador@weg.net)

## EMIRATOS ARABES UNIDOS

Jebel Ali - Dubái  
Teléfono: +971 4 8130800  
[info-ae@weg.net](mailto:info-ae@weg.net)

## ESPAÑA

Coslada - Madrid  
Teléfono: +34 91 6553008  
[info-es@weg.net](mailto:info-es@weg.net)

## ESPAÑA

Valencia  
Teléfono: +34 96 1379296  
[info@autrial.es](mailto:info@autrial.es)

## EEUU

Duluth - Georgia  
Teléfono: +1 678 2492000  
[info-us@weg.net](mailto:info-us@weg.net)

Bluffton - Indiana  
Teléfono: +1 800 5798527  
[info-us@weg.net](mailto:info-us@weg.net)

Minneapolis - Minnesota  
Teléfono: +1 612 3788000  
[info-us@weg.net](mailto:info-us@weg.net)

Washington - Missouri  
Teléfono: +1 636 239 9300  
[wegwill@weg.net](mailto:wegwill@weg.net)

## FRANCIA

Saint-Quentin-Fallavier - Isère  
Teléfono: +33 4 74991135  
[info-fr@weg.net](mailto:info-fr@weg.net)

## GHANA

Accra  
Teléfono: +233 30 2766490  
[ghana@zestweg.com](mailto:ghana@zestweg.com)

## INDIA

Bangalore - Karnataka  
Teléfono: +91 080 46437450  
[info-in@weg.net](mailto:info-in@weg.net)

Hosur - Tamil Nadu  
Teléfono: +91 4344 301577  
[info-in@weg.net](mailto:info-in@weg.net)

## ITALIA

Cinisello Balsamo - Milano  
Teléfono: +39 2 61293535  
[info-it@weg.net](mailto:info-it@weg.net)

## JAPON

Yokohama - Kanagawa  
Teléfono: +81 45 5503030  
[info-jp@weg.net](mailto:info-jp@weg.net)

## MALASIA

Shah Alam - Selangor  
Teléfono: +60 3 78591626  
[info@wattdrive.com.my](mailto:info@wattdrive.com.my)

## MEXICO

Huehuetoca - Mexico  
Teléfono: +52 55 53214275  
[info-mx@weg.net](mailto:info-mx@weg.net)

Tizayuca - Hidalgo  
Teléfono: +52 77 97963790  
[info-mx@weg.net](mailto:info-mx@weg.net)

## PAISES BAJOS

Oldenzaal - Overijssel  
Teléfono: +31 541 571080  
[info-nl@weg.net](mailto:info-nl@weg.net)

## PERU

La Victoria - Lima  
Teléfono: +51 1 2097600  
[info-pe@weg.net](mailto:info-pe@weg.net)

## PORTUGAL

Maia - Porto  
Teléfono: +351 22 9477700  
[info-pt@weg.net](mailto:info-pt@weg.net)

## RUSIA y CEI

Saint Petersburg  
Teléfono: +7 812 363 2172  
[sales-wes@weg.net](mailto:sales-wes@weg.net)

## SINGAPOR

Singapor  
Teléfono: +65 68589081  
[info-sg@weg.net](mailto:info-sg@weg.net)

Singapor  
Teléfono: +65 68622220  
[info-sg@weg.net](mailto:info-sg@weg.net)

## SUDAFRICA

Johannesburg  
Teléfono: +27 (0) 11 7236000  
[info@zestweg.com](mailto:info@zestweg.com)

Cape Town  
Teléfono: +27 (0) 21 507 7200  
[gentsets@zestweg.com](mailto:gentsets@zestweg.com)

Heidelberg  
Teléfono: +27 (0) 16 349 2683/4/5  
[wta@zestweg.com](mailto:wta@zestweg.com)

## SUECIA

Mölnlycke - Suecia  
Teléfono: +46 31 888000  
[info-se@weg.net](mailto:info-se@weg.net)

## REINO UNIDO

Redditch - Worcestershire  
Teléfono: +44 1527 513800  
[info-uk@weg.net](mailto:info-uk@weg.net)

## VENEZUELA

Valencia - Carabobo  
Teléfono: +58 241 8210582  
[info-ve@weg.net](mailto:info-ve@weg.net)

Para los países donde no hay una operación WEG, encuentre el distribuidor local en [www.weg.net](http://www.weg.net).



Grupo WEG - Unidad Automatización  
Jaraguá do Sul - SC - Brasil  
Teléfono: +55 (47) 3276-4000  
[automacao@weg.net](mailto:automacao@weg.net)  
[www.weg.net](http://www.weg.net)

